

BRAKE FLUID BLEEDING

HINT:

- If any work is done on the brake system or if air in the brake lines is suspected, bleed the air from the system.
- When bleeding, keep the amount of the fluid within the line of reservoir between Min. and Max.

NOTICE:

- **Do not let brake fluid remain on painted surfaces. Wash it off immediately.**
- **With the reservoir cap removed, when depressing the brake pedal, the fluid will spray.**

1. FILL RESERVOIR WITH BRAKE FLUID

Fluid: SAE J1703 or FMVSS NO.116 DOT3

2. BLEED HYDRAULIC BRAKE BOOSTER WITH HAND-HELD TESTER

HINT:

If the hydraulic brake booster has been disassembled, disconnect the brake line from the hydraulic brake booster or if the reservoir becomes empty, bleed the hydraulic brake booster.

- Turn the ignition switch OFF, depress the brake pedal more than 40 times.
- Turn the ignition switch ON, check that the pump stops after 30 to 40 seconds.

NOTICE:

When the pump does not stop, repeat step (a) and (b) again.

- With the ignition switch remained ON, depress the brake pedal more than 20 times.
- Observe the procedure in step 4 and bleed the right and left front brake caliper.
- Holding the brake pedal depressed, bleed the right and left rear brake caliper.

HINT:

It is not necessary to depress the pedal continuously, as brake fluid flows out by first depressing.

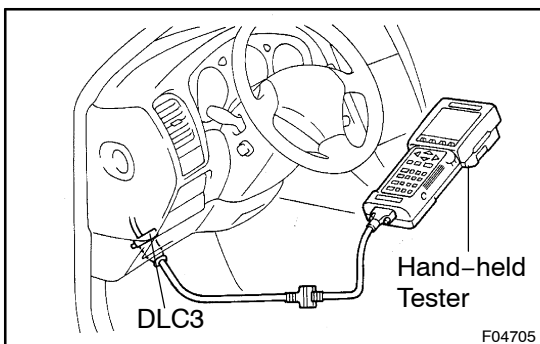

(f) Connect hand-held tester.

- Turn the ignition switch OFF, connect the hand-held tester to DLC3.
- Turn the ignition switch ON and select "AIR BLEEDING" on the hand-held tester.

HINT:

Please refer to the hand-held tester operator's manual for further details.

- (g) Bleed right front brake line.
 - (1) Select "FR LINE" on the hand-held tester.
 - (2) With "FR LINE" turned ON with the hand-held tester, depress the brake pedal and hold it to bleed the right front brake caliper.
- (h) Bleed left front brake line.
 - (1) Select "FL LINE" on the hand-held tester.
 - (2) With "FL LINE" turned ON with the hand-held tester, depress the brake pedal and hold it to bleed the left front brake caliper.
 - (3) Repeat step (2) until there are no more air bubbles in the fluid.
- (i) Bleed rear brake line.
 - (1) Select "RR LINE" on the hand-held tester.
 - (2) With "RR LINE" turned ON with the hand-held tester, bleed the left and right rear brake caliper.
- (j) Disconnect the hand-held tester from DLC3.
- (k) Clear the DTC (See page DI-210)

3. BLEED HYDRAULIC BRAKE BOOSTER WITH ACTUATOR CHECKER (SST)

HINT:

If the hydraulic brake booster has been disassembled, disconnect the brake line from the hydraulic brake booster or if the reservoir becomes empty, bleed the hydraulic brake booster.

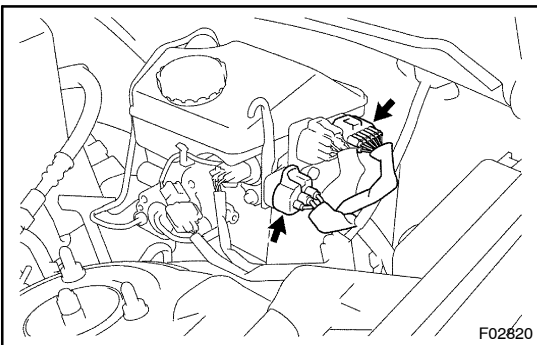

- (a) Disconnect the 2 connectors from the hydraulic brake booster.

- (b) Connect the actuator checker (SST) to the hydraulic brake booster side wire harness via the sub-wire harness (SST), as shown in the chart below.

SST 09990-00150, 09990-00480

HINT:

Connect the connector with the label of "AIR BLEED" attached to the connector of actuator checker.

- (c) Connect the red cable of the checker to the battery positive (+) terminal and the black cable to the negative (-) terminal.

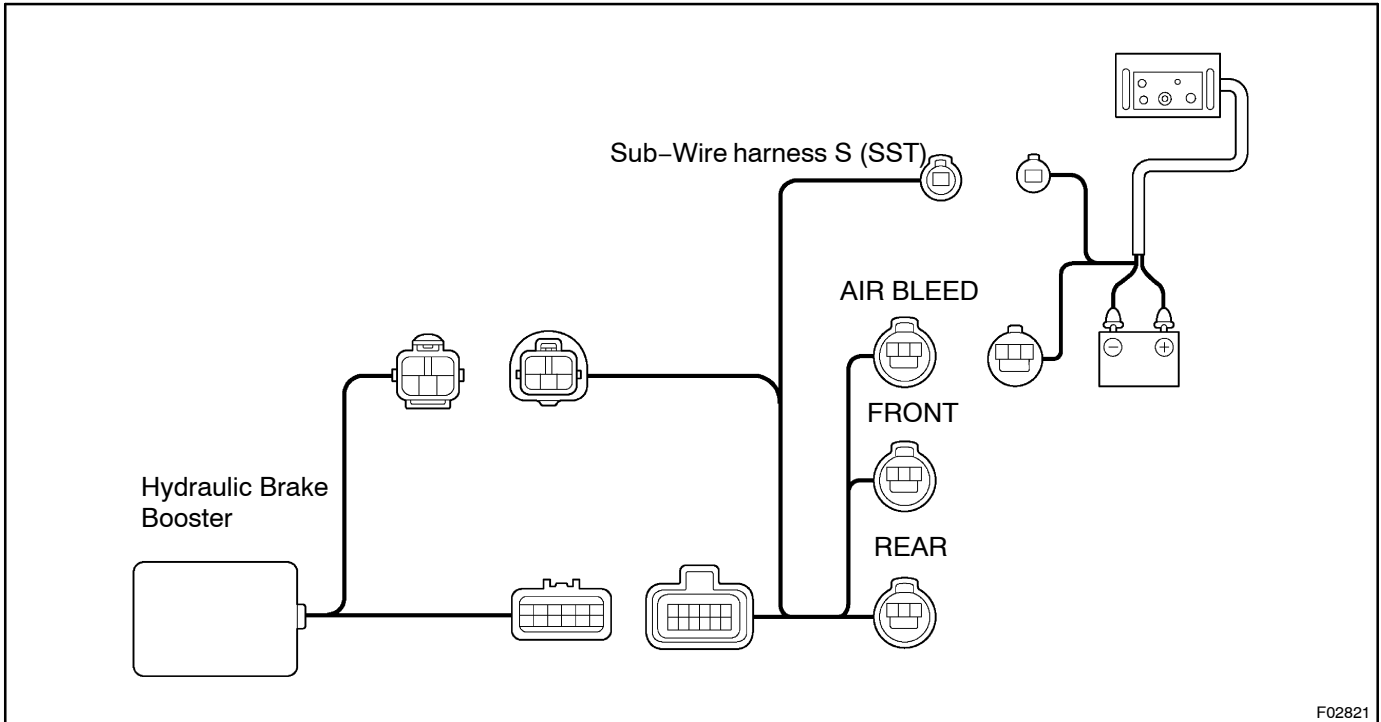

- (d) Turn the ignition switch OFF, depress the brake pedal more than 40 times.
- (e) Turn the ignition switch ON, check that the pump stops after 30 to 40 seconds.

NOTICE:

When the pump does not stop, repeat step (d) and (e) again.

- (f) With the ignition switch remained ON, depress the brake pedal more than 20 times.
- (g) Observe the procedure in step 4 and bleed the right and left front brake caliper.
- (h) Holding the brake pedal depressed, bleed the right and left rear brake caliper.

HINT:

It is not necessary to depress the pedal continuously, as brake fluid flows out by first depressing.

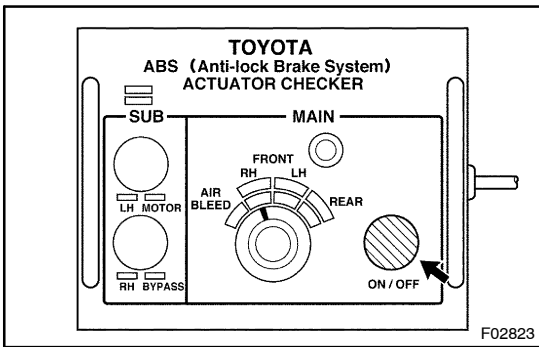

- (i) Bleed right front brake line.
- (1) Turn the selector switch of the actuator checker to the "FRONT RH" position.
 - (2) Push and hold in MAIN push switch, depress the brake pedal and hold it to bleed the right front brake caliper.

NOTICE:

Do not keep the MAIN switch pushed in for more than 10 seconds. When operating it continuously, set the interval of more than 20 seconds.

- (3) Repeat step (2) until there are no more air bubbles in the fluid.

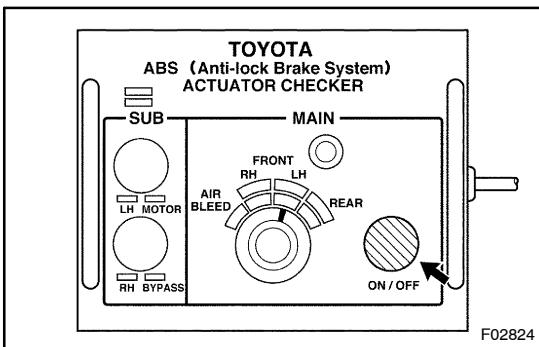

- (j) Bleed left front brake line.
- (1) Turn the selector switch of the actuator checker to the "FRONT LH" position.
 - (2) Push and hold in the MAIN push switch, depress the brake pedal and hold it to bleed the left front brake caliper.

NOTICE:

Do not keep the MAIN switch pushed in for more than 10 seconds. When operating it continuously, set the interval of more than 20 seconds.

- (3) Repeat step (2) until there are no more air bubbles in the fluid.

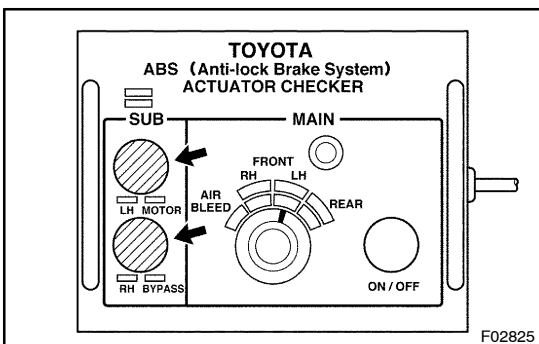

- (k) Bleed right rear brake line.
- (1) Push and hold in the "SUB LH" and "SUB RH" switches, bleed the right rear brake caliper.

NOTICE:

Do not keep the "SUB LH" and "SUB RH" switches pushed in for more than 10 seconds. When operating it continuously, set the interval of more than 20 seconds.

- (2) Repeat step (1) until there are no more air bubbles in the fluid.

- (l) Observe the procedure in step (k) and bleed left rear brake line.
- (m) Disconnect the actuator checker (SST) and sub-wire harness (SST) from the actuator.
SST 09990-00150, 09990-00480
- (n) Connect the 2 connectors to the hydraulic brake booster.
- (o) Clear the DTC (See page DI-210)

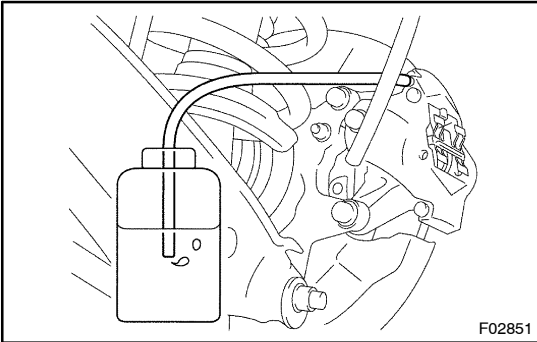

4. BLEED BRAKE LINE

- (a) Connect the vinyl tube to the brake caliper.
- (b) Depress the brake pedal several times, then loosen the bleeder plug with the pedal held down.
- (c) At the point when fluid stops coming out, tighten the bleeder plug, then release the brake pedal.
- (d) Repeat (b) and (c) until all the air in the fluid has been bled out.
- (e) Repeat the above procedure to bleed the brake line for each wheel.

Torque: 11 N·m (110 kgf·cm, 8 ft·lbf)

5. CHECK FLUID LEVEL IN RESERVOIR

- (a) With the ignition switch OFF, depress the brake pedal more than 40 times.
- (b) Remove the reservoir cap. Add brake fluid up to the "MAX" line.

Fluid: SAE J1703 or FMVSS NO.116 DOT3