

## MANUAL CLOSE OPERATION

### NOTICE:

- When operating the roof panel manually, make sure that the audio system is turned OFF and the radio antenna is retracted.
- Perform these roof procedures with at least 2 people.

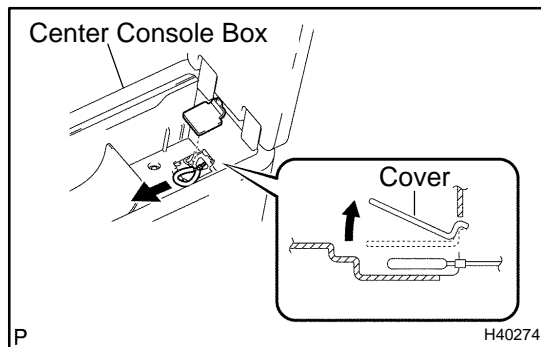

### 1. RELEASE LUGGAGE DOOR LOCK

- Open the cover of the center console box and turn fold back the mat.
- Remove the cover.
- Pull the luggage door lock release wire to unlock the luggage door.

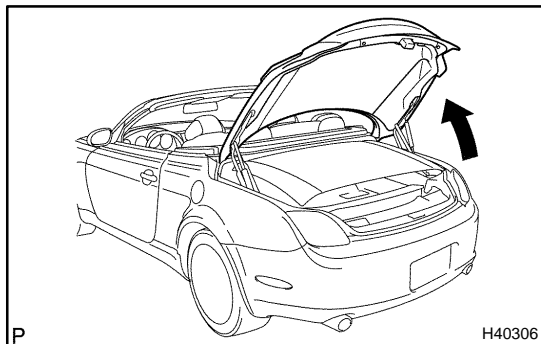

### 2. FULLY OPEN LUGGAGE COMPARTMENT DOOR

- Fully open the door.

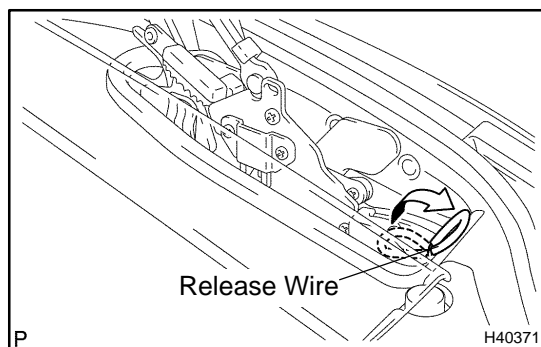

### 3. OPEN LUGGAGE COMPARTMENT DOOR FROM FRONT SIDE

- Pull out the luggage front lock release wire.

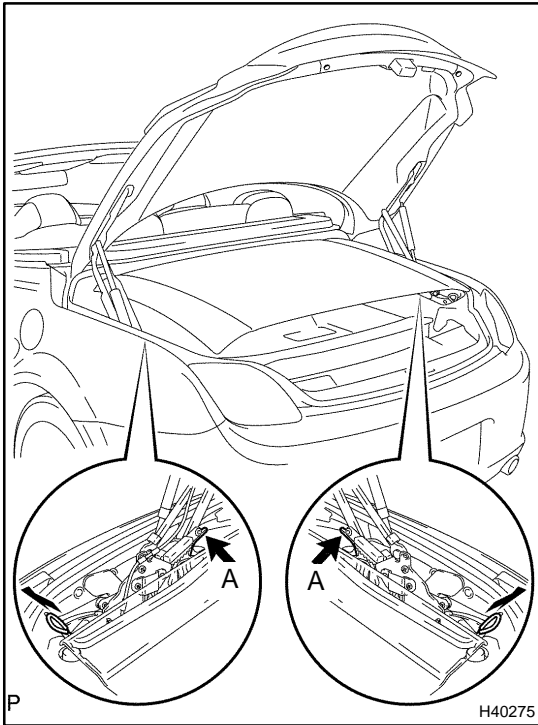

(b) While pulling the wire, slowly raise the luggage link part labeled A.

**NOTICE:**

- A large amount of force is required to raise the luggage link.
- To prevent part deformation, only apply force to the luggage link part labeled A.
- Equally raise the right and left sides of the luggage link.

**HINT:**

The luggage link part labeled A is green.

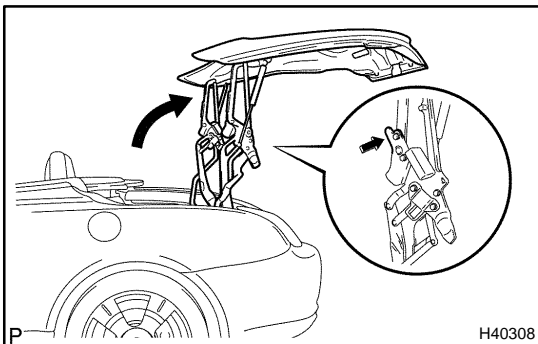

(c) Open the luggage compartment door from the front side as shown in the illustration.

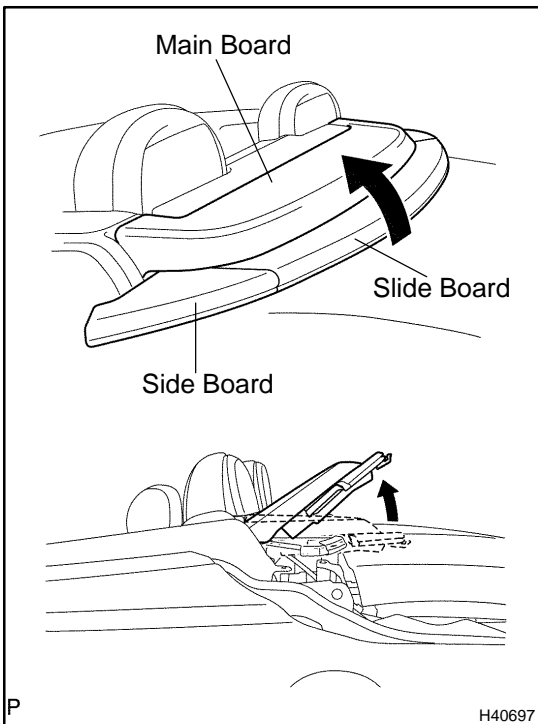

**4. RAISE PACKAGE TRAY TRIM**

(a) Place both hands under the rear part of the package tray in positions close to both ends. Raise the package tray trim gradually to 30° to 45°.

**CAUTION:**

Do not place your hands on the edges of the main board.

**NOTICE:**

Do not apply direct force to the side board as it is operated in connection with the main board.

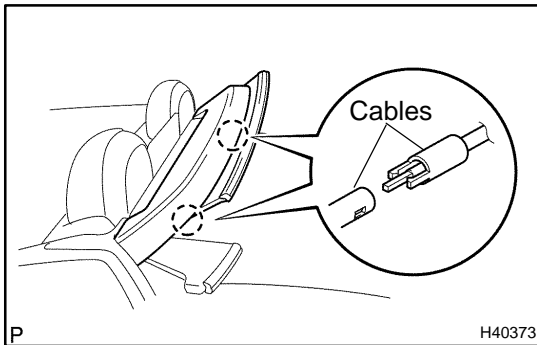

- (b) Disconnect the joints of the cables from the package tray trim gear box.

**CAUTION:**

Take care not to injure your hands when disconnecting the joints.

**NOTICE:**

- As the cable is coated with grease, prevent it from contacting the seat, seat belt or other parts.
- Make sure the removed cable is not pressed against the package tray trim gear box.

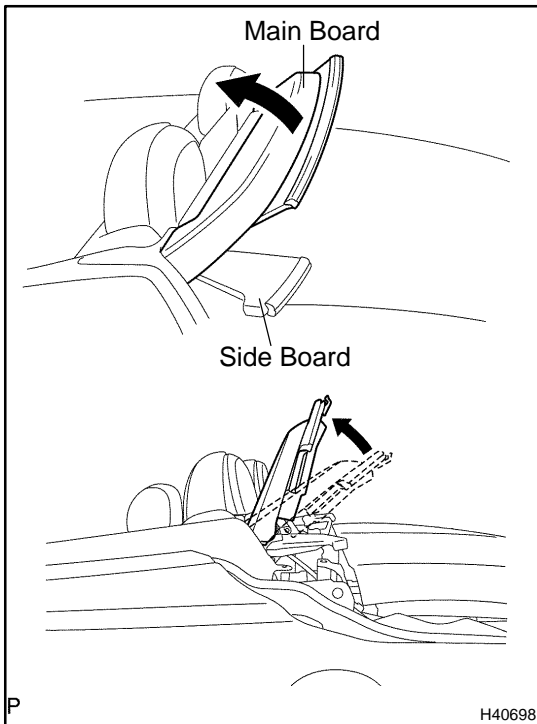

- (c) Raise the package tray trim gradually until it stops.

**NOTICE:**

Do not apply direct force to the side board as it is operated in connection with the main board.

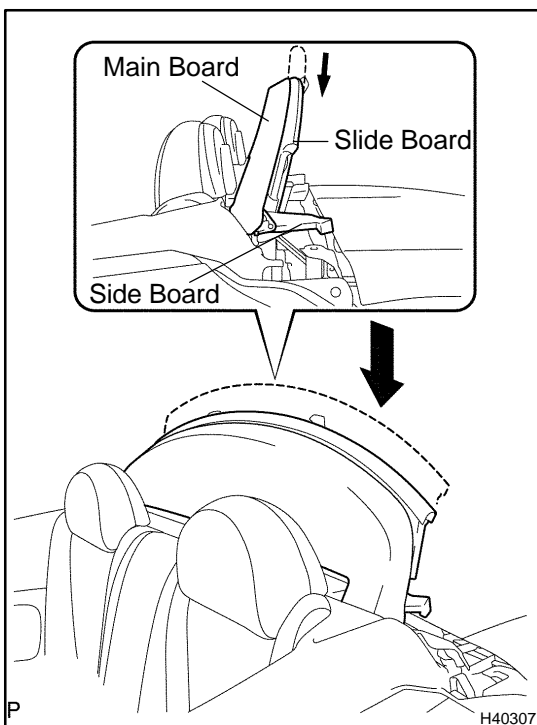

- (d) Place both your hands on the slide board in positions close to both ends.

**NOTICE:**

Do not touch the side board.

- (e) Push down the slide board until the slide board is the same height as the main board.

**HINT:**

When the slide board is lowered, the side board will automatically retract.

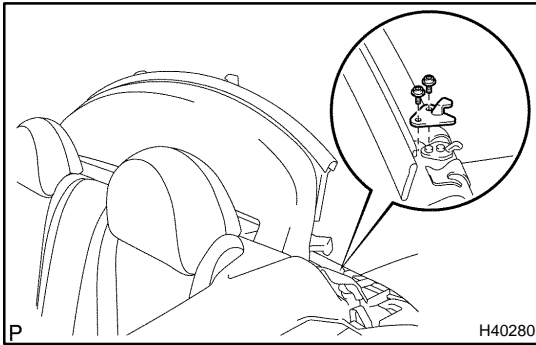

## 5. REMOVE ROOF STOPPER

- (a) Using a hexagon wrench, remove the 2 bolts.

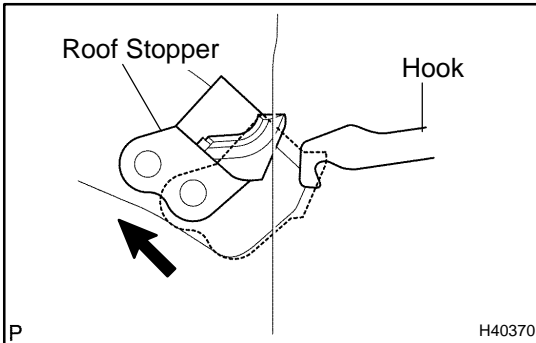

- (b) Slide the roof stopper and take it off from the hook.

**HINT:**

Use the same procedures described for the other side.

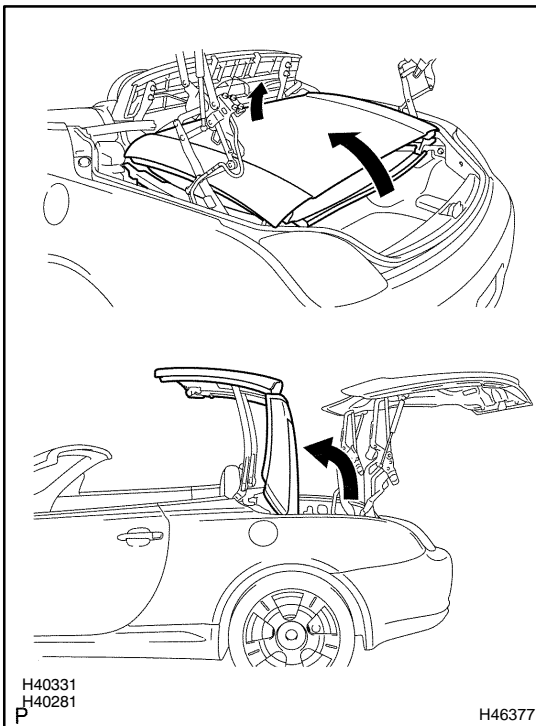

## 6. HALF CLOSE ROOF PANEL

- (a) Gradually raise the roof panel with your hands until the back window stands upright. While performing this procedure, raise the front side of the roof slightly.

**HINT:**

Place your hands at the lower part of the roof.

**NOTICE:**

**Equally raise the right and left sides of the roof panel.**

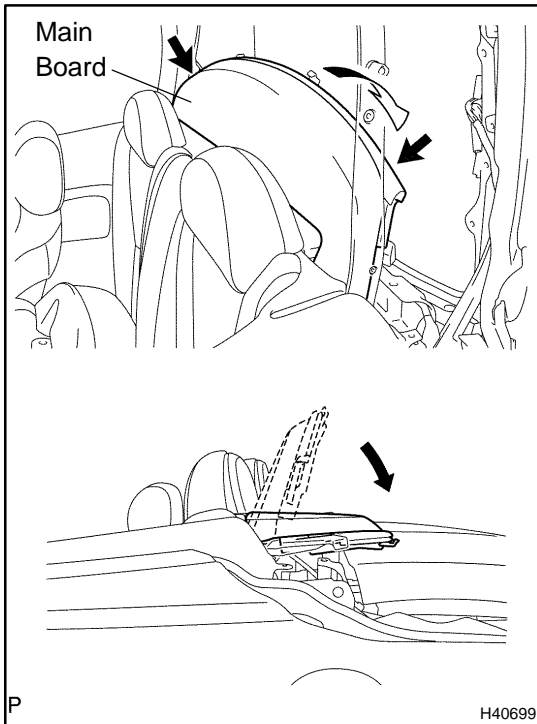

## 7. FOLD DOWN PACKAGE TRAY TRIM

- (a) Slowly fold down the package tray trim.

### CAUTION:

Do not place your hands on the edges of the main board.

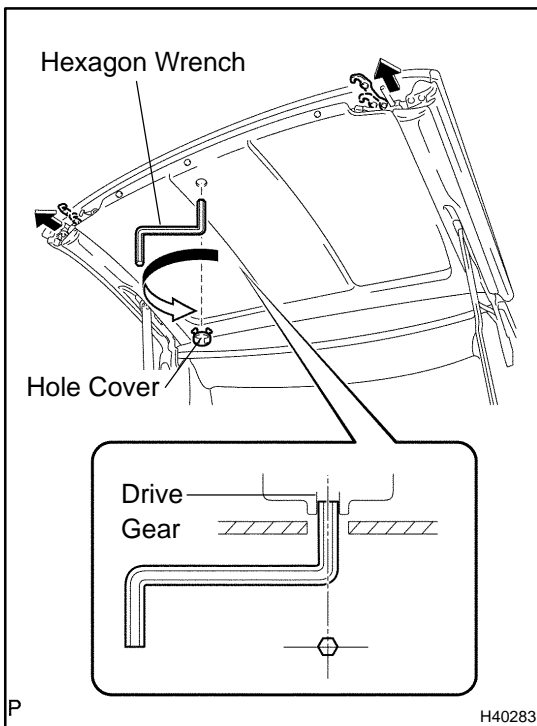

## 8. RELEASE REMOVABLE ROOF LOCK

- (a) Remove the service hole cover from the roof headlining.
- (b) Insert the hexagon wrench tip into the drive gear shaft. Turn the hexagon wrench counterclockwise (as viewed from under the roof) to unlock the roof lock.

### NOTICE:

Turn the hexagon wrench as much as possible, but do not apply excessive force.

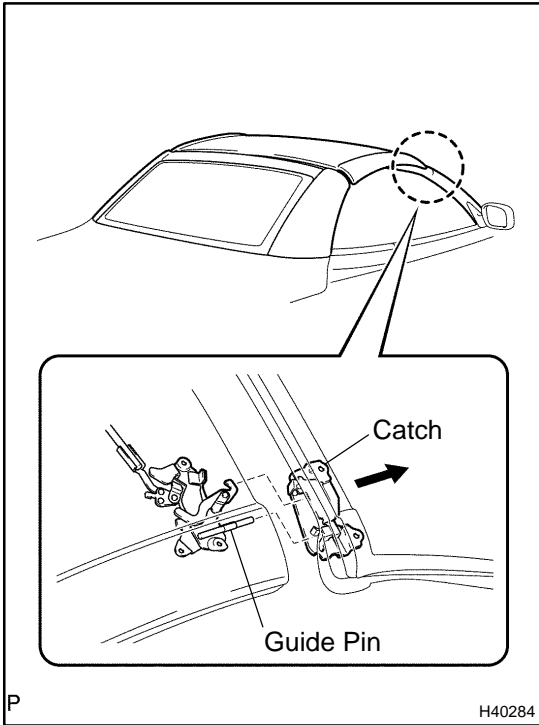

**9. FULLY CLOSE ROOF PANEL**

- (a) Place your hands on the roof panel and back window. Slowly close the roof panel.

**NOTICE:**

**Equally lower the right and left sides of the roof panel.**

- (b) Check that the guide pin on the edge of the roof panel is aligned with the catch on the pillar.

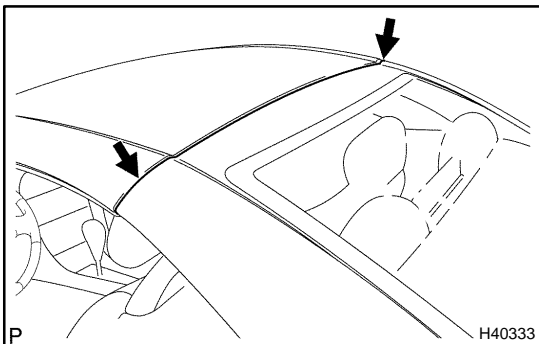

- (c) Firmly push downward the roof panel and back window near the parting line.

**NOTICE:**

**Push down equally on the right and left sides of the roof panel/back window.**

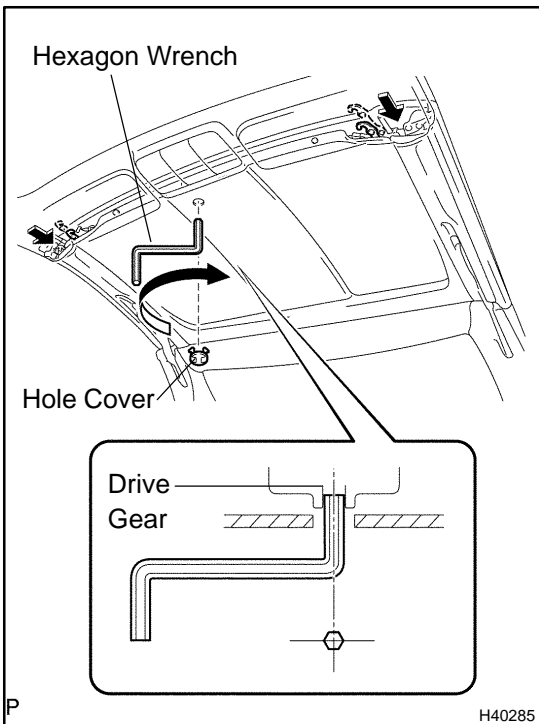

**10. LOCK REMOVABLE ROOF LOCK**

- (a) Insert the hexagon wrench tip into the driver gear shaft in the roof headlining. Turn the roof lock clockwise (as viewed from under the roof) to lock the roof lock.

**NOTICE:**

**Turn the hexagon wrench as much as possible, but do not apply excessive force.**

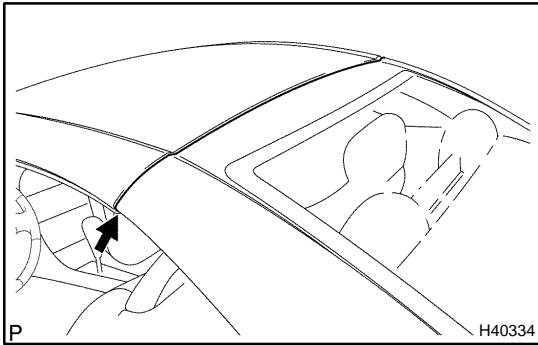

- (b) Check that the roof panel and back window are locked by pushing upward near the parting line.

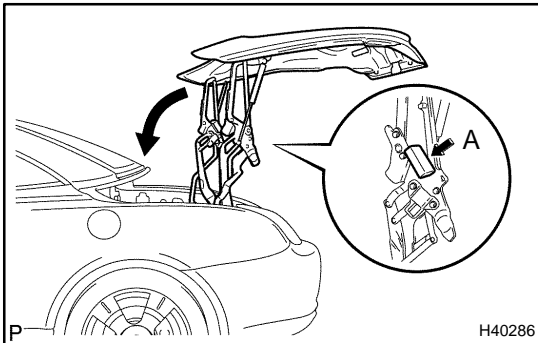

- 11. CLOSE LUGGAGE COMPARTMENT DOOR FRONT**  
 (a) Place your hands on the luggage link part labeled A and slowly apply force downward to lower the luggage link.  
 (b) After moving the luggage link to the lowermost position, firmly press down on it again.

**NOTICE:**

- Equally lower the right and left sides of the luggage link.
- A large amount of force is required to initially move the luggage link.

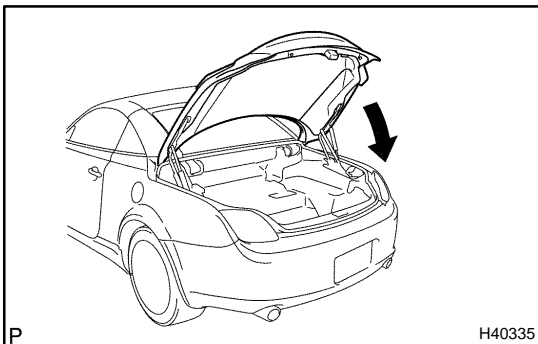

**12. CLOSE LUGGAGE COMPARTMENT DOOR REAR**

- (a) Close the door.

**13. CLOSE QUARTER WINDOW**

- (a) Turn the ignition switch ON.  
 (b) Turn the luggage opener main switch from ON to OFF.  
 (c) Within 10 seconds after step (b), push the roof opener switch on the OPEN side twice.  
 (d) Within 10 seconds after step (c), push and hold the roof opener switch on the CLOSE side until the quarter window are closed.

**NOTICE:**

If step (d) is not performed correctly, perform procedures from step (b) again.

