

FEATURES

- **Silent**
Noise has been reduced by approximately 20 dB, using our own silencing design.
- **Twin (1 Form C × 2)**
Forward/reverse motor control is possible with a single relay.
- **Sealed construction**
• Simple footprint enable ease of PC

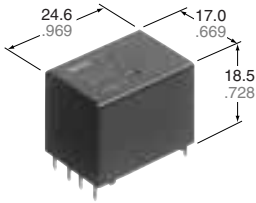

mm inch

board layout

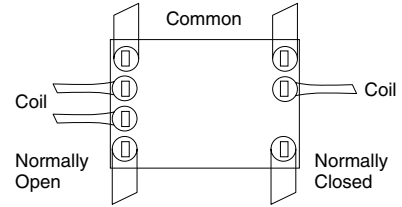

SPECIFICATIONS

Contact

Arrangement	1 Form C × 2 (H bridge)		
Contact material	Silver alloy		
Initial contact resistance (By voltage drop 6 V DC 1A)	Max. 100 mΩ		
Contact voltage drop	Max. 0.2V (at 10 A)		
Rating	Nominal switching capacity	N.O.: 20 A 14 V DC N.C.: 10 A 14 V DC	
	Max. carrying current	35 A for 2 minutes, 25 A for 1 hour (12 V, at 20°C/68°F) 30 A for 2 minutes, 20 A for 1 hour (12 V, at 85°C/185°F)	
	Min. switching capacity#1	1 A 12 V DC	
Expected life (min. operations)	Mechanical (at 120 cpm)	Min. 10 ⁷	
		Electrical	Resistive load
	Motor load		Min. 2×10 ⁵ *2
		Min. 10 ⁵ *3	

Coil

Nominal operating power	640 mW
-------------------------	--------

#1 This value can change due to the switching frequency, environmental conditions, and desired reliability level, therefore it is recommended to check this with the actual load.

Remarks

- *1 At nominal switching capacity, operating frequency: 1s ON, 9s OFF
- *2 N.O.: at 5 A (steady), 25 A (inrush)/N.C.: at 20 A (brake) 14 V DC, operating frequency: 0.5s ON, 9.5s OFF
- *3 At 20A 14 V DC (Motor lock), operating frequency: 0.5s ON, 9.5s OFF
- *4 Measurement at same location as "Initial breakdown voltage" section
- *5 Detection current: 10mA
- *6 Excluding contact bounce time
- *7 Half-wave pulse of sine wave: 11ms; detection: 10μs
- *8 Half-wave pulse of sine wave: 6ms

Characteristics

Max. operating speed (at nominal switching capacity)	6 cpm	
Initial insulation resistance*4	Min. 100 MΩ (at 500 V DC)	
Initial breakdown voltage*5	Between open contacts	500 Vrms for 1 min.
	Between contacts and coil	500 Vrms for 1 min.
Operate time*6 (at nominal voltage)(at 20°C/68°F)	Max. 10 ms (initial)	
Release time*6 (at nominal voltage)(at 20°C/68°F)	Max. 10 ms (initial)	
Shock resistance	Functional*7	Min. 100 m/s ² {10G}
	Destructive*8	Min. 1,000 m/s ² {100G}
Vibration resistance	Functional*9	10 Hz to 100 Hz, Min. 44.1 m/s ² {4.5G}
	Destructive*10	10 Hz to 500 Hz, Min. 44.1 m/s ² {4.5G}
Conditions for operation, transport and storage*11 (Not freezing and condensing at low temperature)	Ambient temperature	-40°C to +85°C -40°F to +185°F
	Humidity	5% R.H. to 85% R.H.
Mass	Approx. 12.5g.44 oz	

- *9 Detection time: 10μs
- *10 Time of vibration for each direction;
X, Y, direction: 2 hours
Z direction: 4 hours



*11 Refer to 6. Conditions for operation, transport and storage mentioned in AMBIENT ENVIRONMENT

TYPICAL APPLICATIONS

- Power windows
- Auto door lock
- Electrically powered sunroof
- Electrically powered mirror, etc.

ORDERING INFORMATION

Ex. CR 2 - 12 V

Contact arrangement	Coil voltage(DC)
1 Form C × 2	12 V

Standard packing: Carton(tube package) 32pcs. Case: 800pcs.

TYPES AND COIL DATA (at 20°C 68°F)

Part No.	Nominal voltage, V DC	Pick-up voltage, V DC (Initial)*	Drop-out voltage, V DC (Initial)	Coil resistance, Ω	Nominal operating current, mA	Nominal operating power, mW	Usable voltage range, V DC
CR2-12V	12	Max. 7.2	Min. 1.0	225±10%	53.3±10%	640	10 to 16

* Other pick-up voltage types are also available. Please contact us for details.

DIMENSIONS

mm inch

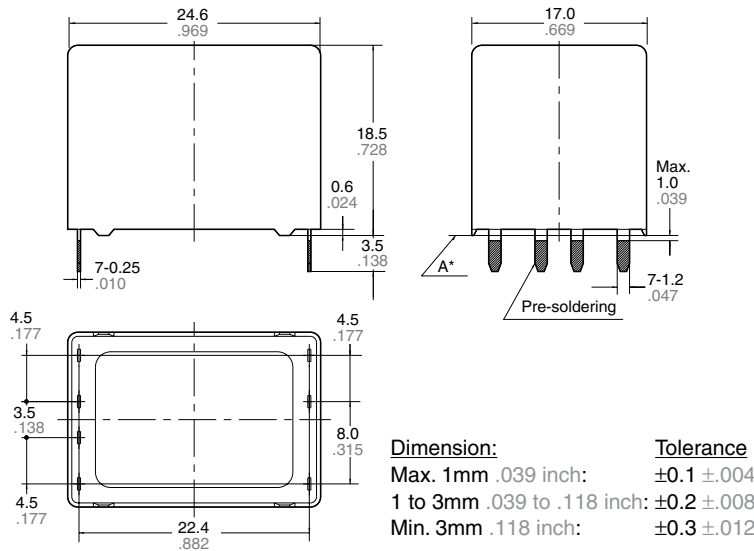

PC board pattern (Bottom view)

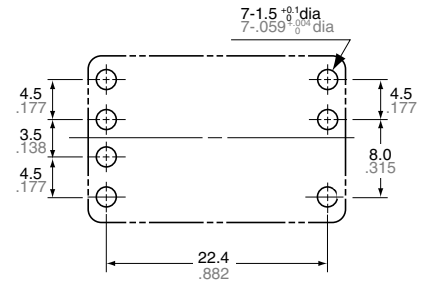

Tolerance: ±0.1 ±.004

Schematic (Bottom view)

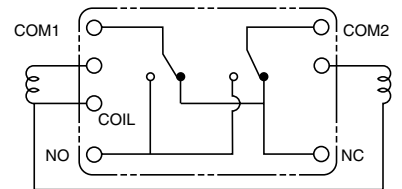

* Dimensions (thickness and width) of terminal specified in this catalog is measured before pre-soldering. Intervals between terminals is measured at A surface level.

EXAMPLE OF CIRCUIT

Forward/reverse control circuits of DC motor for power window

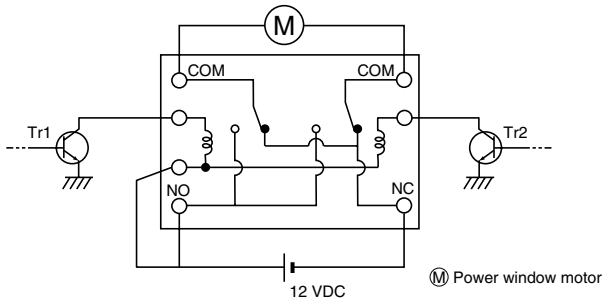

Tr1	Tr2	Motor
OFF	OFF	Stop
ON	OFF	Forward
OFF	ON	Reverse

REFERENCE DATA

1-(1). Coil temperature rise (at room temperature)
 Sample: CR2-12V, 5pcs
 Contact carrying current: 10A, 15A, 20A
 Ambient temperature: Room temperature

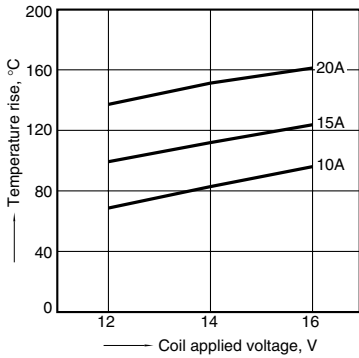

1-(2). Coil temperature rise (at 85°C 185°F)
 Sample: CR2-12V, 5pcs
 Contact carrying current: 10A, 15A
 Ambient temperature: 85°C 185°F

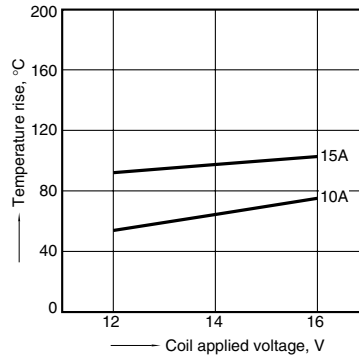

2. Max. switching capability (Resistive load)

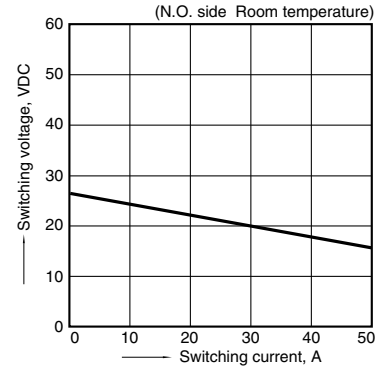

3. Ambient temperature and operating temperature range

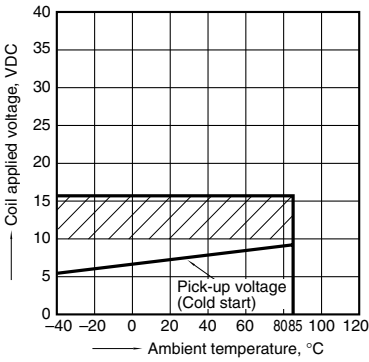

4. Ambient temperature characteristics

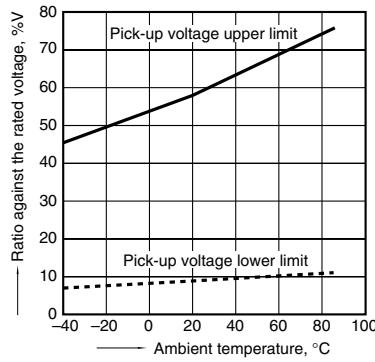

5. Distribution of pick-up and drop-out voltage
 Sample: CR2-12V, 100pcs

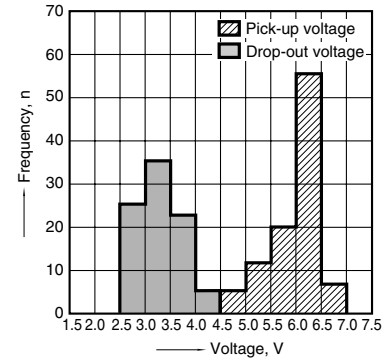

6. Distribution of operate time
 Sample: CR2-12V, 100pcs

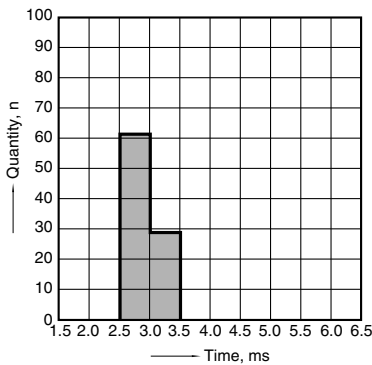

7. Distribution of release time
 Sample: CR2-12V, 100pcs
 * With diode

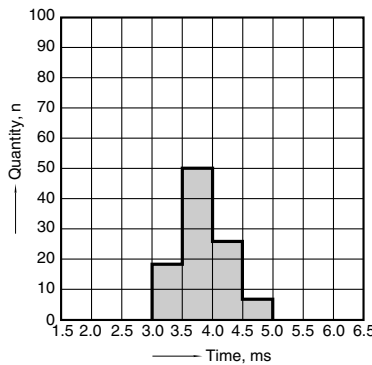

8-(1). Operation noise distribution
 When operated

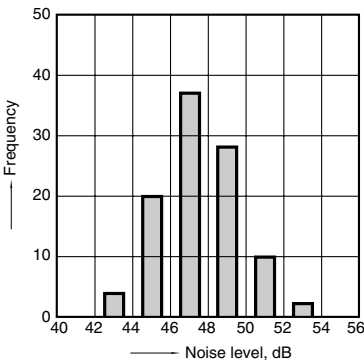

8-(2). Operation noise distribution
 When released

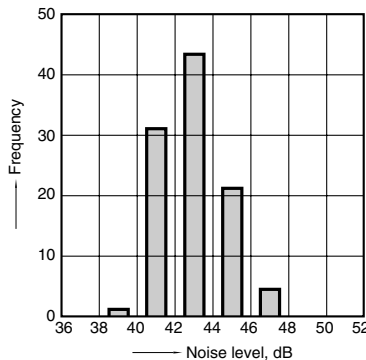

Measuring conditions

Sample: CR2-12 V, 50 pcs.
 Equipment setting: "A" weighted, Fast, Max. hold
 Coil voltage: 12V DC
 Coil connection device: Diode
 Background noise: Approx. 20dB

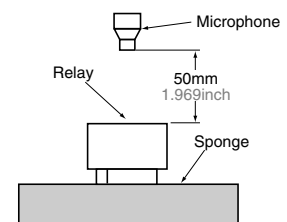

9-(1). Electrical life test (Motor free)

Sample: CR2-12V, 3pcs
 Load: Inrush current: 25A, Steady current: 6A,
 Brake current: 15A,
 power window motor actual load (free condition)
 Tested voltage: 14V DC
 Ambient temperature: Room temperature

Circuit

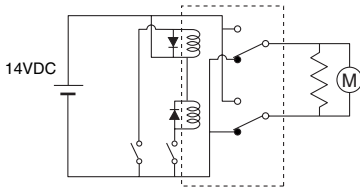

Change of pick-up and drop-out voltage

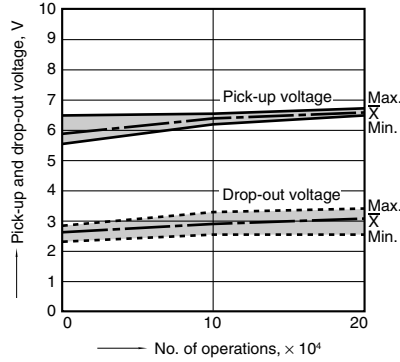

Change of contact resistance

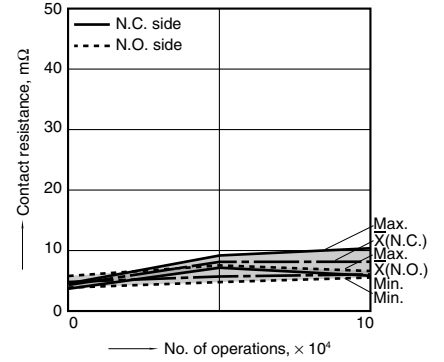

Load current waveform

Inrush current: 25A, Steady current: 6A,
 Brake current: 15A
 Tested voltage: 14V DC



9-(2). Electrical life test (Motor lock)

Sample: CR2-12V, 3pcs
 Brake current: 22A,
 power window motor actual load (lock condition)
 Tested voltage: 14V DC
 Switching frequency: (ON:OFF = 0.5s:9.5s)
 Ambient temperature: Room temperature

Circuit

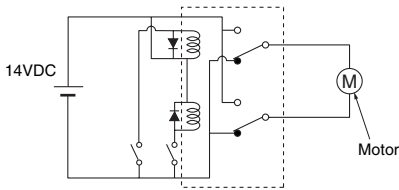

Change of pick-up and drop-out voltage

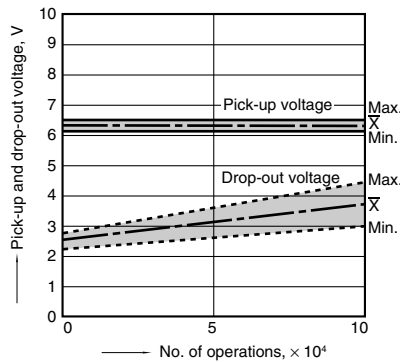

Change of contact resistance

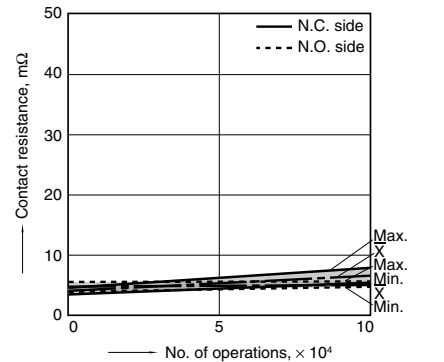

Load current waveform

Brake current: 22A
 Tested voltage: 14V DC

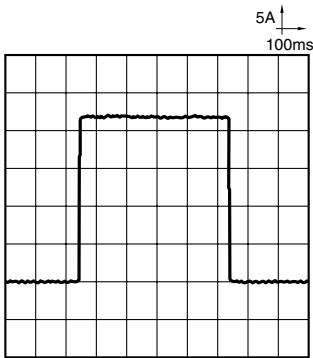

For Cautions for Use, see Relay Technical Information