

Section 10

ABS DIAGNOSIS

CIRCUIT DESCRIPTION

This relay supplies power to each ABS solenoid. After the ignition switch is turned ON, if the initial check is OK, the relay goes on.

DTC No.	Diagnostic Trouble Code Detecting Condition	Trouble Area
11	Conditions (1) and (2) continue for 0.2 sec. or more: (1) ABS control (solenoid) relay terminal (SR) voltage: Battery positive voltage (2) ABS control (solenoid) relay monitor terminal (AST) voltage: 0 V	<ul style="list-style-type: none"> • ABS control (solenoid) relay • Open or short in ABS control (solenoid) relay circuit • ECU
12	Conditions (1) and (2) continue for 0.2sec. or more: (1) ABS control (solenoid) relay terminal (SR) voltage: 0 V (2) ABS control (solenoid) relay monitor terminal (AST) voltage: Battery positive voltage	<ul style="list-style-type: none"> • ABS control (solenoid) relay • B+ short in ABS control (solenoid) relay circuit • ECU

Fail safe function: If trouble occurs in the control (solenoid) relay circuit, the ECU cuts off current to the ABS control (solenoid) relay and prohibits ABS control.

WIRING DIAGRAM

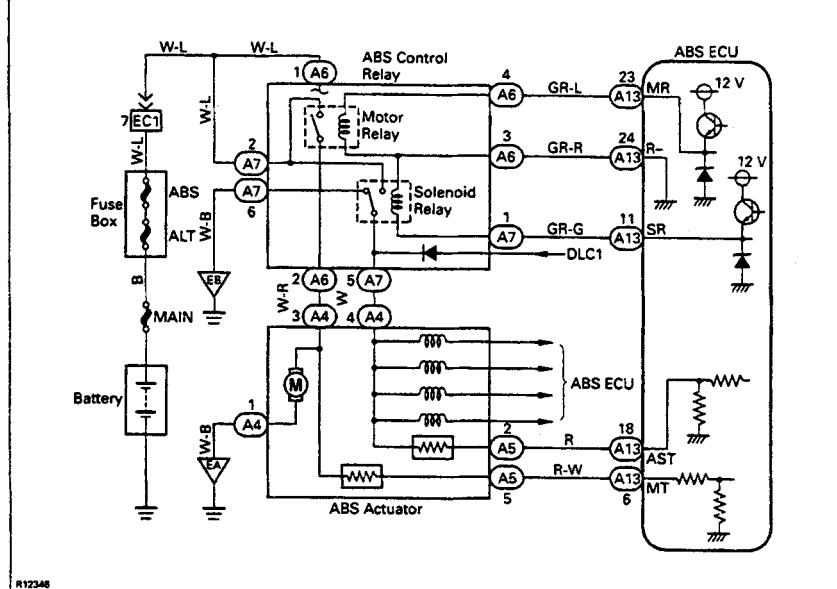

- Lesson Objectives**
1. Using the actuator tester and the appropriate Repair Manual and/or TSB, select the proper SSTs to use in diagnosing an ABS system.
 2. Using the On-Board Diagnosis (OBD) system and a Repair Manual, perform a dynamic diagnosis of speed sensors and deceleration sensor.
 3. Using a Repair Manual perform the self-diagnosis to access trouble codes to determine malfunctions within the ABS and/or TRAC systems.

Diagnosis and Troubleshooting

The ABS ECU has a self-diagnostic system which monitors the input and output circuits. The ABS ECU operates the solenoid valves and the pump motor in sequence in order to check each respective electrical system. This function operates only once each time the ignition switch is turned ON. On some earlier models it operates when the vehicle is traveling at a speed greater than 4 mph with the stop light (brake light) switch OFF. During this check the operation of the actuator can be heard, however this is normal and does not indicate a malfunction.

Initial Check Function

The check function may vary depending on the number of solenoids.

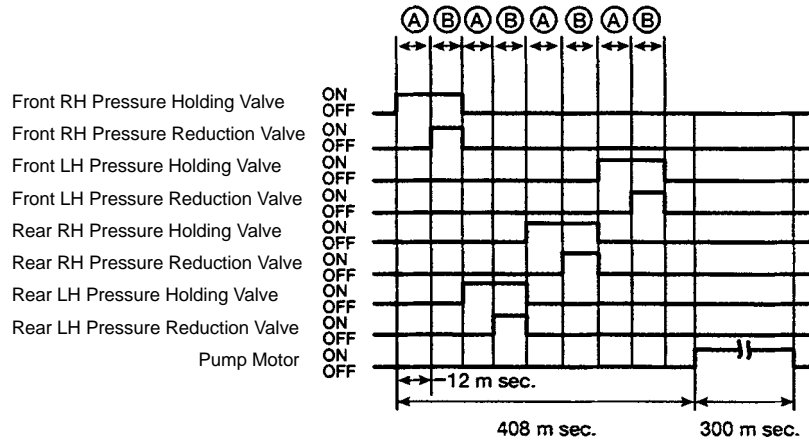

Diagnostic Function

When a problem is detected in any of the signal systems, the ECU turns on the ABS warning light in the combination meter to alert the driver that a malfunction has occurred. The code is stored in memory for access at a later time. Diagnostic trouble codes can be read from the Warning light. The ABS ECU will also store the diagnostic trouble codes for any ABS malfunction.

ABS Warning Light

The light warns the driver of an ABS malfunction.

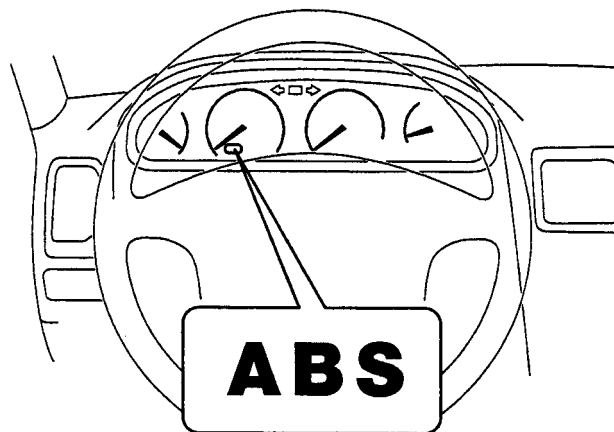

Trouble Code Check To access the diagnostic trouble codes stored in the ECU, locate the Data Link Connector (DLC1) or (DLC2). Consult the Repair Manual or the ABS Reference Card to determine whether the ABS Check Connector is physically disconnected or the short pin for Wa and Wb is removed.

To access diagnostic codes:

- Disconnect the check connector or remove the short pin in DLC1.
- Jumper terminals Tc and E1 of the Data Link Connector (DLC1 or DLC2).
- Turn the ignition switch ON and read the trouble code from the ABS warning light on the Combination Meter.

NOTE Camry and Avalon w/Bosch ABS, no Short Pin. Jumper Tc and E1.

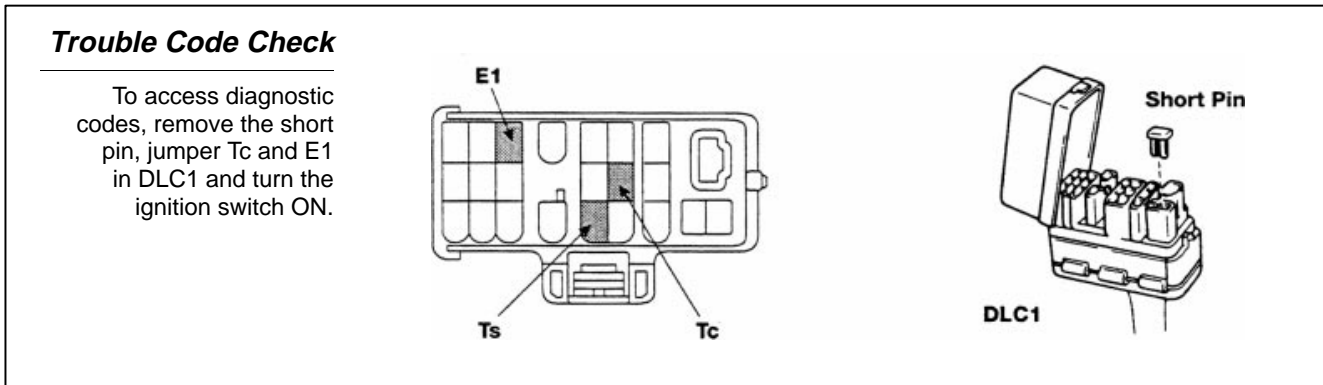

Diagnostic Codes If the computer has not detected a malfunction, the lamp will blink two times per second after a two second pause. When a malfunction has been detected there will be a 4 second pause, then the first digit will begin. The number of times the lamp blinks before a one and a half second pause is the first digit of the code. Next, the number of blinks before the second pause is the second digit of the code. In the example below, the first code is Code 11 and the second code is 21.

If there is more than one trouble code, the code with the smallest number will appear first, followed by a pause for 2.5 seconds, then the next code

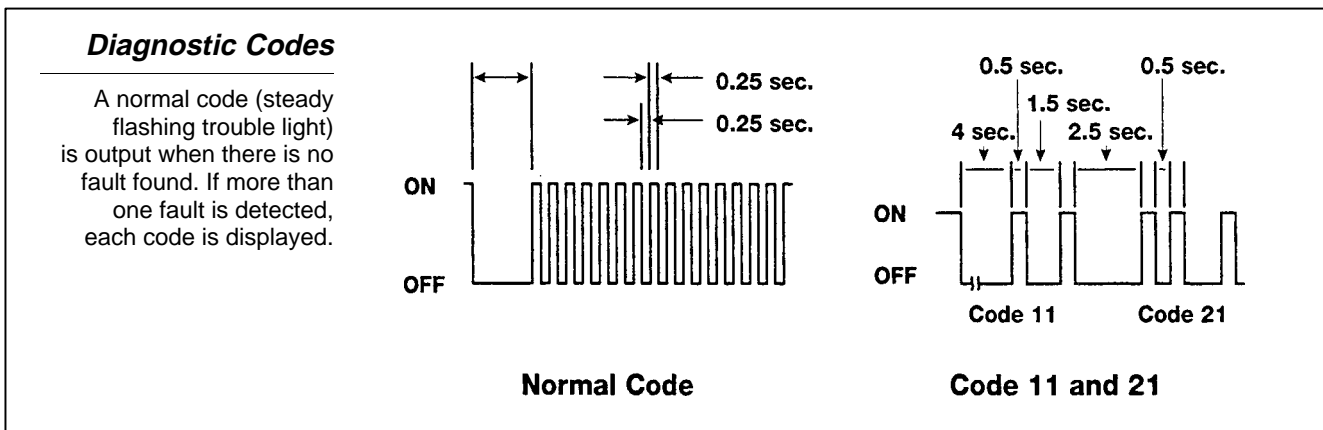















will appear in the same manner as described earlier. Finally, the entire procedure will be repeated after a four second pause.

The chart below identifies each code and reveals the circuit or component which requires further diagnosis. The total number of diagnostic codes may vary between vehicles so it is important to refer to the Repair Manual for the specific vehicle you are diagnosing.

Trouble Code Chart

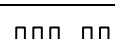
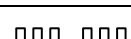
The code identifies the component or circuit which requires further diagnosis.

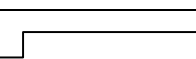
Code	ABS Warning Light Blinking Pattern	Diagnosis
11	ON OFF  BE3831	Open circuit in ABS control (solenoid) relay circuit
12	ON OFF  BE3831	Short circuit in ABS control (solenoid) relay circuit
13	ON OFF  BE3831	Open circuit in ABS control (motor) relay circuit
14	ON OFF  BE3831	Short circuit in ABS control (motor) relay circuit
21	ON OFF  BE3832	Open or short circuit in 3-position solenoid circuit for right front wheel
22	ON OFF  BE3832	Open or short circuit in 3-position solenoid circuit for left front wheel
23	ON OFF  BE3832	Open or short circuit in 3-position solenoid circuit for right rear wheel
24	ON OFF  BE3832	Open or short circuit in 3-position solenoid circuit for left rear wheel
31	ON OFF  BE3833	Right front wheel speed sensor signal malfunction
32	ON OFF  BE3833	Left front wheel speed sensor signal malfunction
33	ON OFF  BE3833	Right rear wheel speed sensor signal malfunction
34	ON OFF  BE3832	Left rear wheel speed sensor signal malfunction
35	ON OFF  BE3833	Open circuit in left front or right rear speed sensor circuit
36	ON OFF  BE3833	Open circuit in right front or left rear speed sensor circuit
37	ON OFF  BE3833	Faulty rear speed sensor rotor
41	ON OFF  BE3834	Low battery positive voltage or abnormally high battery positive voltage
51	ON OFF  BE3836	Pump motor is locked Open in pump motor ground
Always on	ON OFF  BE3836	Malfunction in ECU

Circuit Inspection The Repair Manual takes the diagnosis several steps further in providing a circuit inspection and inspection procedure for each diagnostic code. It provides a circuit description as well as the parameters under which the code was set for each stored code. A wiring diagram schematic of the electrical circuit is also provided for ready reference.

Circuit Description and Wiring Diagram

A circuit description includes the parameters for setting the code.

CIRCUIT DESCRIPTION

This relay supplies power to each ABS solenoid. After the ignition switch is turned ON, if the initial check is OK, the relay goes on.

DTC No.	Diagnostic Trouble Code Detecting Condition	Trouble Area
11	Conditions (1) and (2) continue for 0.2 sec. or more: (1) ABS control (solenoid) relay terminal (SR) voltage: Battery positive voltage (2) ABS control (solenoid) relay monitor terminal (AST) voltage: 0 V	<ul style="list-style-type: none"> • ABS control (solenoid) relay • Open or short in ABS control (solenoid) relay circuit • ECU
12	Conditions (1) and (2) continue for 0.2sec. or more: (1) ABS control (solenoid) relay terminal (SR) voltage: 0 V (2) ABS control (solenoid) relay monitor terminal (AST) voltage: Battery positive voltage	<ul style="list-style-type: none"> • ABS control (solenoid) relay • B+ short in ABS control (solenoid) relay circuit • ECU

Fail safe function: If trouble occurs in the control (solenoid) relay circuit, the ECU cuts off current to the ABS control (solenoid) relay and prohibits ABS control.

WIRING DIAGRAM

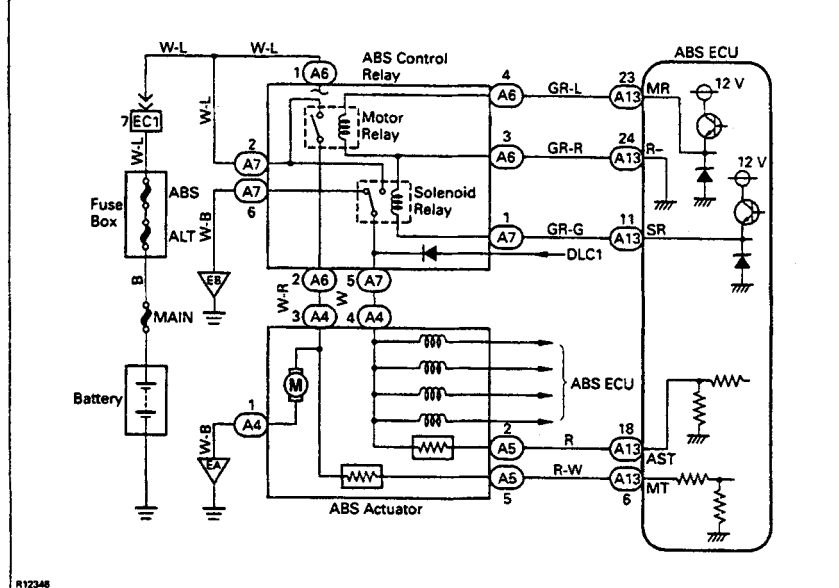

An inspection procedure follows the circuit inspection with components, connectors, pin locations and measurement values to diagnose the circuit. Each step is outlined in sequence, leading to a repair.

Inspection Procedure

The inspection procedure includes components, connectors and pin locations as well as measurement values to diagnose the circuit.

1 Check voltage between terminals (A7) 2 and (A7) 6 of ABS control relay connector.

LOCK 

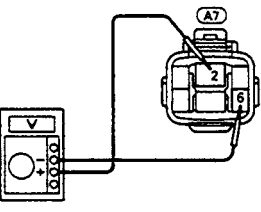

P Disconnect the ABS control relay connector.

C Measure voltage between terminals (A7) 2 and (A7) 6 of ABS control relay harness side connector.

OK Voltage: 10 - 14 V

OK 

NG Check and repair harness or connector.

2 Check continuity between terminals (A7) 5 and (A4) 4, (A4) 4 and (A5) 2, (A5) 2 and (A13) 18.

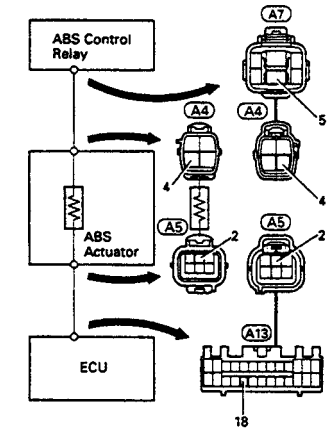

P Disconnect the 2 connectors from ABS actuator.

C Check continuity between terminals (A7) 5 and (A4) 4, (A4) 4 and (A5) 2, (A5) 2 and (A13) 18.

OK Continuity

HINT: There is a resistance of 4 - 6 Ω between terminals (A4) 4 and (A5) 2.

OK 

NG Repair or replace harness or ABS actuator.

Diagnostic Trouble Code Clearance

Following diagnosis and repair, clear the trouble codes stored in the ECU. The procedure will vary depending on the model and year. Either refer to the ABS Reference Card or Repair Manual for specifics. The essential difference is in disconnecting the actuator check connector on earlier models as compared to the removal of the short pin connector in the DLC1 or DLC2 connector. A typical procedure is outlined below:

- Jumper terminals Tc and E1 of the DLC2 or DLC1 and remove the short pin from DLC1.
- Turn ignition switch ON.
- Depress the brake pedal 8 or more times within 3 seconds.
- Check that the warning light shows the normal code.
- Remove the jumper wire and reinstall the short pin.

To ensure that the brake light switch opens and closes each time, allow the brake pedal to return to the full up position each time when clearing codes. If the code does not clear, the ignition switch must be cycled OFF then ON before depressing the brake pedal 8 times in 3 seconds.

Clearing Diagnostic Trouble Codes

6. Remove jumper wire and reinstall the short pin

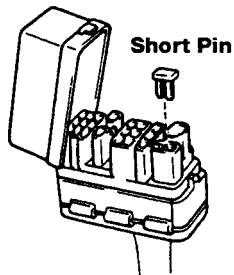

5. Check for Normal Code at Warning Light

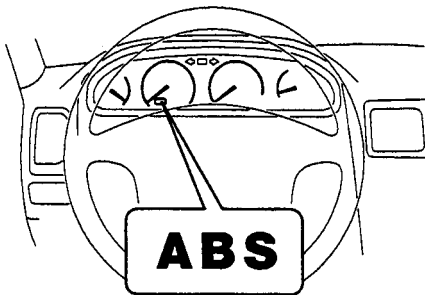

1. Jumper Tc and E1 in DLC1

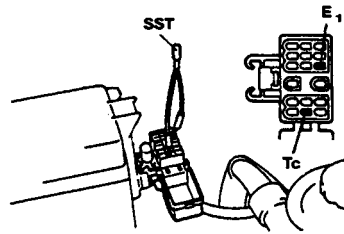

2. Remove the short pin from DLC1

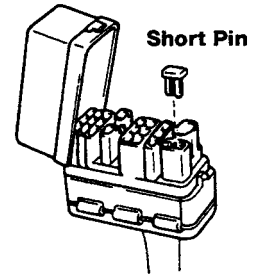

3. Turn Ignition Switch ON

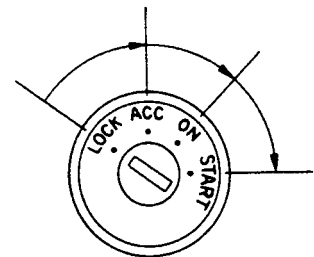

4. Depress the brake pedal 8 or more times within 3 seconds

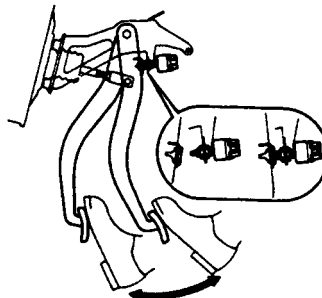

Speed Sensor Signal Check Eight additional diagnostic codes (71 through 78) are available to trouble-shoot the speed sensors and rotors. They determine whether the signal to the ECU is a low output voltage or an abnormal change in output voltage. When using the signal check, make sure that the vehicle is driven straight ahead.

The ECU is placed in signal check mode differently based on model and year, so again it is important to have the appropriate repair manual available. In some early models, the parking brake in conjunction with the service brake were used to enter this mode.

In most cases, connect terminals Tc and E1 at DLC1 prior to driving the vehicle. To read the code:

- Connect terminals Ts and E1 (Tc and E1 remain connected).
- In earlier models the actuator check connector was disconnected.

Diagnostic Trouble Codes for Speed Sensor Check Function

Consult the Repair Manual for specific instructions to place the ECU into the diagnostic mode and to read the codes.

Code No.	Diagnosis	Trouble Area
71	Low output voltage of right front speed sensor	<ul style="list-style-type: none"> • Right front speed sensor • Sensor installation
72	Low output voltage of left front speed sensor	<ul style="list-style-type: none"> • Left front speed sensor • Sensor installation
73	Low output voltage of right rear speed sensor	<ul style="list-style-type: none"> • Right rear speed sensor • Sensor installation
74	Low output voltage of left rear speed sensor	<ul style="list-style-type: none"> • Left rear speed sensor • Sensor installation
75	Abnormal change in output voltage of right front speed sensor	<ul style="list-style-type: none"> • Right front speed sensor rotor
76	Abnormal change in output voltage of left front speed sensor	<ul style="list-style-type: none"> • Left front speed sensor rotor
77	Abnormal change in output voltage of right rear speed sensor	<ul style="list-style-type: none"> • Right rear speed sensor rotor
78	Abnormal change in output voltage of left rear speed sensor	<ul style="list-style-type: none"> • Left rear speed sensor rotor

Deceleration Sensor Check The deceleration sensor can be checked both statically and dynamically. Jumpering E1 and Ts at DLC1 and observing the ABS light are the essential steps.

Static Testing With Ts and E1 jumpered and the engine running, raise the rear of the vehicle slowly to the specified height as described in the Repair Manual, then observe the ABS light. The light should blink 4 times per second. If the light remains ON, inspect the sensor installation. If its properly installed, replace the deceleration sensor.

Lower the vehicle slowly and then raise the front slowly to the specified height and observe the light as in the procedure described above.

Static Testing

Raising the front and rear separately to a specific height and note the condition of the ABS light.

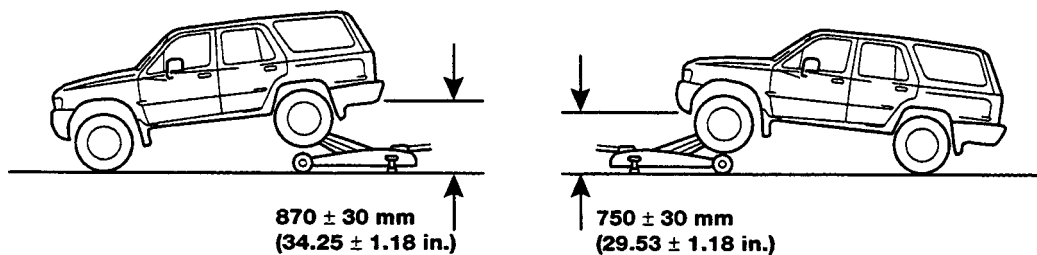

Dynamic Testing For most vehicles except 1996 RAV4, jumper terminals Ts and E1 in DLC1, drive the vehicle straight forward at about 12 mph:

- Lightly depress the brake pedal and the light should remain flashing 4 times per second.
- Bring the speed up to 12 mph or more and depress the brake pedal moderately hard and the light should come on while braking.
- Bring the speed up to 12 mph or more and depress the brake pedal strongly and again the light should come on while braking. If the light does not operate as specified, inspect the sensor installation. If the installation is OK, replace the deceleration sensor.

RAV4 Static Test The RAV4 deceleration sensor is tested after removal from the vehicle.

- assemble three 1.5 volt dry cell batteries in series.
- connect the positive side of the battery to terminal VGS and the negative side to the GGND.
- check the output of GL1 and GL2 terminals with a voltmeter comparing your readings with the chart below.

CAUTION

Do not turn the sensor upside down when removed from the vehicle. If dropped, it should be replaced.

RAV4 Deceleration Sensor Test

Applies to 1996 RAV4 only.

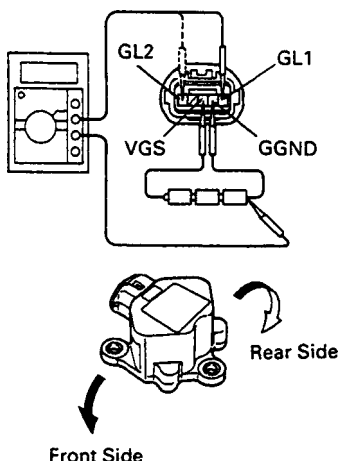

Symbols	Condition	Standard Value
GL1	Horizontal	about 2.3 V
GL1	Lean forward	0 - about 2.3 V
GL1	Lean rearward	about 2.3 V - 4.5 V
GL2	Horizontal	about 2.3 V
GL2	Lean forward	about 2.3 V - 4.5 V
GL2	Lean rearward	0 - about 2.3 V

ABS Actuator Checker

The actuator operation can be checked using a Special Service Tool called an ABS Actuator Checker and related subharness and overlay sheet where needed. This special service tool can check the operation of the solenoid valves and the pump motor. The actuator is disconnected from the vehicle harness, taking the ECU out of the loop and operated independently by the special service tool.

ABS Actuator Checker

This special service tool can check the operation of the solenoid valves, the by-pass valve and the pump motor.

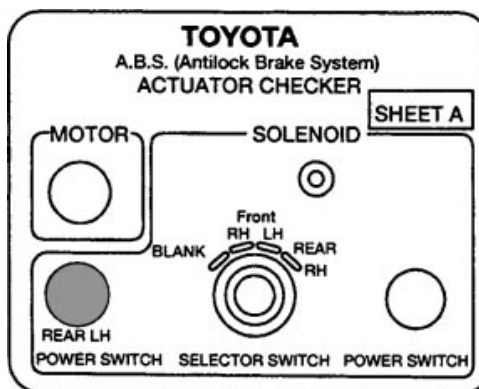

The ABS actuator checker statically checks the operation of the actuator which includes: the pump, solenoids, and relays. If a normal code is displayed, but symptoms still occur, refer to the Problem Symptoms Chart in the Repair Manual. The chart indicates when the checker is to be used.

When to Use Actuator Checker

If a normal code is displayed but symptoms still occur, the Repair Manual chart identifies circuits to check and use of the Actuator Checker.

Symptoms	Inspection Circuit	See page
ABS does not operate.	Only when 1. ~ 4. are all normal and the problem is still occurring, replace the ABS ECU. 1. Check the DTC, reconfirming that the normal code is output. 2. IG power source circuit. 3. Speed sensor circuit. 4. Check the ABS actuator with a checker. If abnormal, check the hydraulic circuit for leakage (see page BR-79).	BR-50 BR-70 BR-66 BR-37
ABS does not operate efficiently.	Only when 1. ~ 4. are all normal and the problem is still occurring, replace the ABS ECU. 1. Check the DTC, reconfirming that the normal code is output. 2. Speed sensor circuit. 3. Stop light switch circuit. 4. Check the ABS actuator with a checker. If abnormal, check the hydraulic circuit for leakage (see page BR-79).	BR-50 BR-66 BR-72 BR-37
ABS warning light abnormal.	1. ABS warning light circuit. 2. ABS ECU.	BR-74
DTC check cannot be done.	Only when 1. and 2. are all normal and the problem is still occurring, replace the ABS ECU. 1. ABS warning light circuit. 2. Tc terminal circuit.	BR-74 BR-76
Speed sensor signal check cannot be done.	1. Ts terminal circuit. 2. ABS ECU.	BR-78

Refer to the Repair Manual for adapter harnesses required and the illustration depicting proper connections. The illustration below shows the connections for Supra models with or without TRAC.

ABS Actuator Checker Installation

Follow the references in the Repair Manual for the proper harnesses and connector configuration. This Supra example shows different adapter harnesses based on it being equipped with Traction Control.

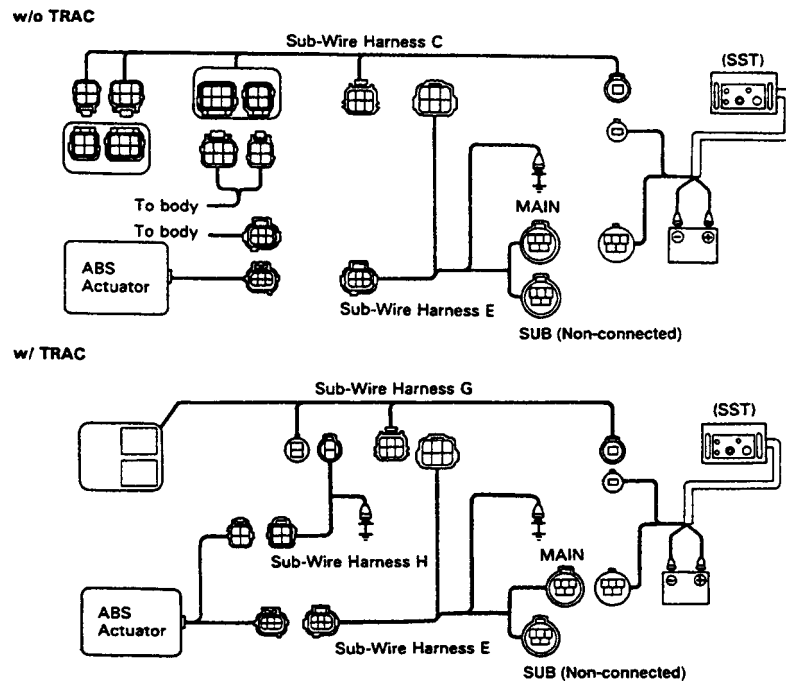

Pay particular attention to the operating procedure as you perform the diagnosis. Note that the illustrations of the checker buttons are darkened to emphasize which ones are pressed for a given step. When the procedure indicates that the pedal goes UP or DOWN it means that the pedal will move a short distance in that direction.

Actuator Checker Overlay

The illustrations of the Actuator Checker buttons in the Repair Manual are darkened to emphasize which ones are pressed for a given step.

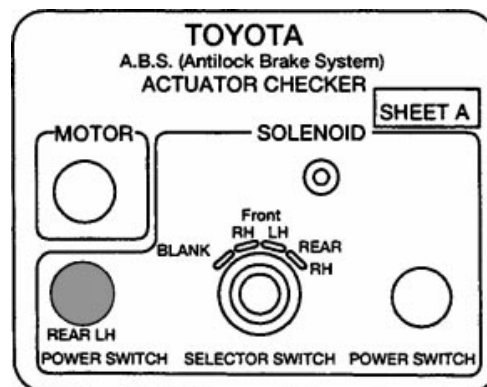

The Actuator cannot be disassembled for service. If a malfunction develops with the solenoid valves or pump motor, the entire ABS Actuator assembly must be replaced.

Bleeding the ABS hydraulic system does not differ from the bleeding procedure of a conventional brake system except for rear wheel ABS. As fluid is bled, it flows through the solenoids to the wheels. The part of the actuator hydraulic circuit going from the solenoids through the No. 1 check valve is sealed to prevent air entry when the ABS is not activated.

If a malfunction occurs in the electrical system to the ECU, current to the actuator from the ECU is turned off. As a result, the brake system operates the same as if the antilock brake system is not operating and normal braking function is assured.

Toyota Diagnostic Tester

Toyota models equipped with a DLC2 connector located under the instrument panel have the capability to read diagnostic codes using the Diagnostic Tester. In addition, ECU pin voltage values on all ABS ECU's can be read on the Tester screen using the Vehicle Break-out Box feature. The Diagnostic Tester has a number of components and harnesses which vary, based on the vehicle and ECU being tested. An Operators Manual is provided with the Tester which describes the test functions and tool set-up. The Vehicle Break-out Box is connected between the vehicle harness and the ECU connectors.

Remember that while diagnosing any electrical system, disconnecting and reconnecting electrical connectors may eliminate a system fault.

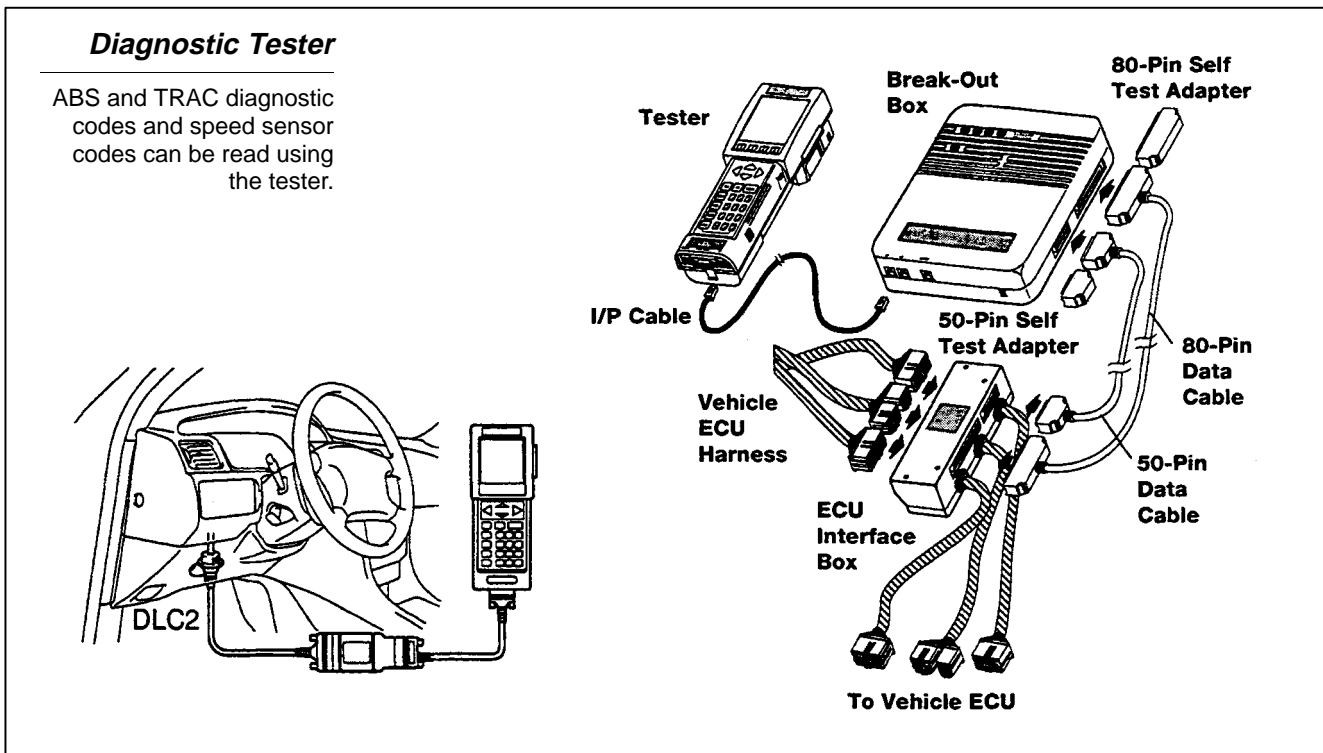



WORKSHEET 10-1 (ON-CAR)
ABS Actuator Checker

Vehicle	Year/Prod. Date	Engine	Transmission
---------	-----------------	--------	--------------

Worksheet Objectives

In this Worksheet you will practice the use of the ABS Actuator Checker (Not to be used with TMM Camry/Avalon).

Tools and Equipment:

- ABS Actuator Checker (09990-00150).
- Vehicle Specific Harness Adapters.
- Vehicle Repair Manual.
- DVOM.
- Jumper Wire or SST 09843-18020.

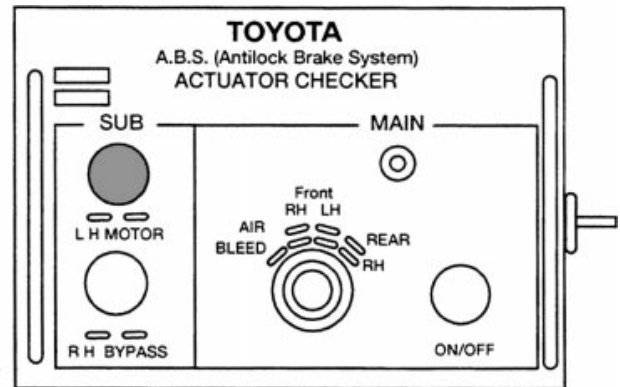

Preparation:

- Disconnect the actuator/control relay electrical connectors.
- Connect the actuator checker to the actuator, control relay and body side harness. Place the cover sheet on to the checker if needed. Refer to the appropriate Repair Manual for the proper adapter harnesses.

Required Adapter Harnesses

Required Checker Cover sheet

Actuator Testing:

1. Inspect battery voltage.

Measured Battery Voltage	Battery Voltage Specification	Pass/Fail

2. Connect the sub-wire harness battery connectors to the battery.
3. Start the engine and run at idle.
4. Turn the selector switch to “FRONT RH” position.
5. Push and hold the MOTOR switch for a few seconds.
6. Depress and hold the brake pedal and push the POWER Switch (do not depress switch for more than 10 seconds).

- a. What happened to the brake pedal?

7. Release the switch and notice the brake pedal action.

- a. What happened to the brake pedal?

- b. What component(s) were checked?

8. While pressing the brake pedal, press the MOTOR Switch for a few seconds.

- a. What happened to the position of the brake pedal?

- b. What component(s) were checked?

9. Depress and hold the brake pedal for 15 seconds. While holding the brake pedal press the MOTOR Switch.

- a. Does the brake pedal pulsate?

10. Turn the main selector switch to the other three wheel positions and repeat the actuator tests above.

11. Disconnect and remove ABS Checker and harnesses.

12. Clear diagnostic codes (if any) from memory.



WORKSHEET 10-2 (ON-CAR) Speed Sensor Signal Check

Vehicle	Year/Prod. Date	Engine	Transmission
---------	-----------------	--------	--------------

Worksheet Objectives

In this Worksheet you will practice the procedure for checking the speed sensor signal.

Tools and Equipment:

- Jumper wire (SST 09843-18020) or equivalent jumper.
- Vehicle Repair Manual.

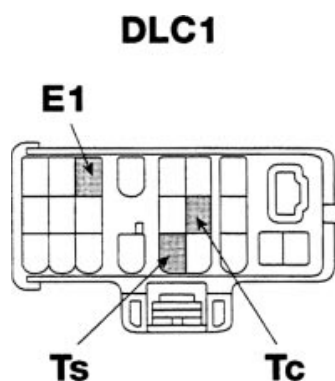

Procedure:

1. Turn the ignition switch OFF.
2. Jumper terminals Ts and E1 at DLC1.
3. Start engine.
4. Check the ABS warning light and record your observation.

a. If the warning light does not blink, what should be checked first?

5. Drive the vehicle faster than 28 mph for several seconds.
 6. Stop the vehicle and jumper terminals Tc and E1 of DLC1.
 7. Record the codes as output by the ABS Warning Light.
-

8. Disconnect terminals Ts and E1 and Tc and E1 at DLC1 and turn ignition switch OFF.

Summary:

1. Answer the following questions for Speed Sensor Code 72.

a. Which sensor is at fault?

b. What is the cause of the fault?

2. Answer the following questions for Speed Sensor Code 78.

a. Which sensor is at fault?

b. What could cause this fault?



WORKSHEET 10-3 (ON-CAR) Toyota Diagnostic Tester

Vehicle	Year/Prod. Date	Engine	Transmission

Worksheet Objectives

In this Worksheet you will practice the use of the Toyota Diagnostic Tester to access ABS diagnostic codes.

Tools and Equipment

- Vehicle Repair Manual.
- Diagnostic Tester (TOY220036).

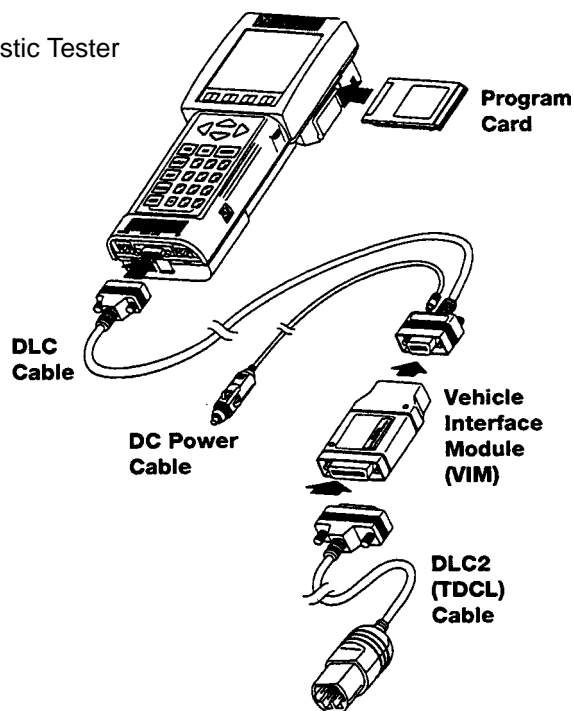
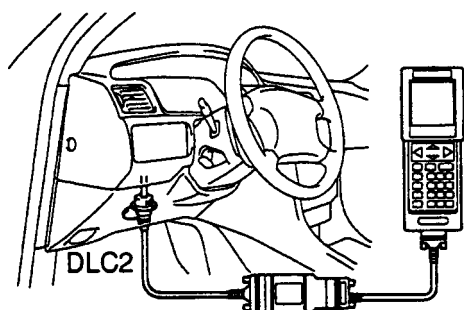

Procedure:

1. Attach the DLC2 Cable, Vehicle Interface Module (VIM) and the DLC Cable to the Tester.
2. Attach the DC Power Cable to the DLC Cable and plug into the auxiliary power source.
3. Connect the DLC2 Cable to the vehicle.
4. Power up the unit and select ENTER.
5. At the Main Menu select OBD and press ENTER.
6. Follow the screen prompts for the vehicle you are working on.
7. At the OBD MENU select CODES (ALL).
8. Record the codes and components/circuits that appear on the tester screen.

9. Clear the diagnostic codes.
 - a. Jumper TC and E1 and remove the short pin in DLC1.
 - b. Turn ignition switch ON.
 - c. Depress the brake pedal 8 or more times within 3 seconds.
 - d. Is the Normal Code given at the warning light?
 - e. Remove jumper wire and install short pin.



Notes



WORKSHEET 10-4 (ON-CAR) Toyota Diagnostic Tester and Vehicle Break-out Box

Vehicle	Year/Prod. Date	Engine	Transmission
---------	-----------------	--------	--------------

Worksheet Objectives

In this Worksheet you will practice the use of the Toyota Diagnostic Tester and Break-out Box to:

- access ABS ECU terminal signals
- access speed sensor oscilloscope patterns

Tools and Equipment

- Vehicle Repair Manual.
- Diagnostic Tester (TOY220036).
- Program Card.
- V-BOB Interface Card.
- V-BOB.
- Misc. V-BOB Harnesses.

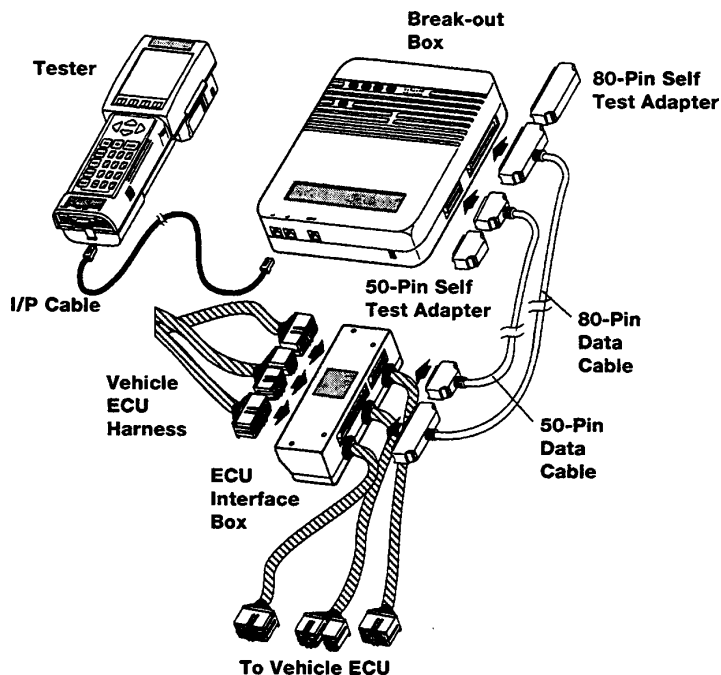

Procedure:

1. Insert the Program Card in the Tester.
2. Connect the I/P Cable to the I/P connector on the bottom of the tester and the I/P connector on the Breakout Box.
3. Connect both the Tester and Break-out Box to a power source.
4. Power up the unit and select ENTER.
5. At the Main Menu select Breakout Box and press ENTER.
6. Follow the screen prompts for the vehicle you are working on.
7. At the Vehicle Confirmation Screen verify the information is correct for the vehicle and select YES.
8. When the vehicle and system have been selected, the Tester displays which ECU Interface Box, harness, and connectors are required to attach the V-BOB.
9. With the ignition switch OFF, disconnect the ECU harness connector.
10. Connect the vehicle harness to the ECU interface Box.
11. Connect the 50-pin and 80-pin Data Cables to the Break-out Box and ECU Interface Box.
12. Select DATA LIST from the Break-out Box Menu.
13. Turn ON the ignition switch and record the values for the items listed below:
IG1_____ MT_____ MR_____ SR_____ AST_____
14. Refer to the Repair Manual or EWD and identify the circuit of each of the terminals above.

IG1 _____
MT _____
MR _____
SR _____
AST _____

Oscilloscope Function:

1. From the Break-out Box Menu select oscilloscope and press ENTER.
2. Select FR+ (for front-wheel-drive) or RR (for rear-wheel-drive) and press ENTER.
3. Drive the vehicle at 15 mph and note the oscilloscope pattern height and frequency.
 - a. Pause screen
 - b. Print Screen or copy the oscilloscope pattern in the space below (SEND)
4. Drive the vehicle at 30 mph and note the oscilloscope pattern.
 - a. Pause screen
 - b. Print Screen or copy the oscilloscope pattern in the space below

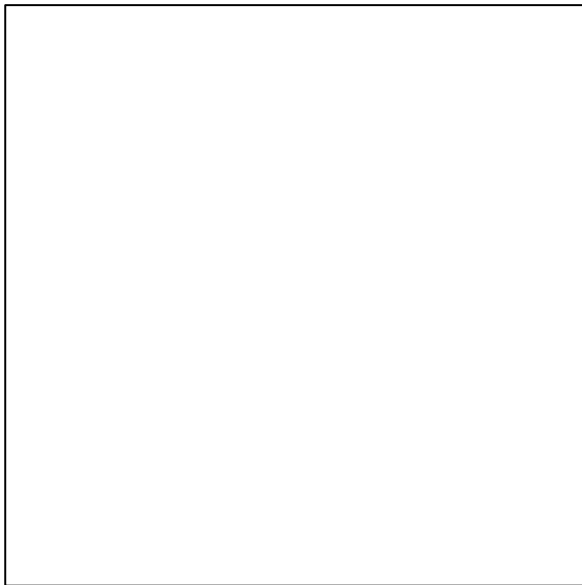

3b.

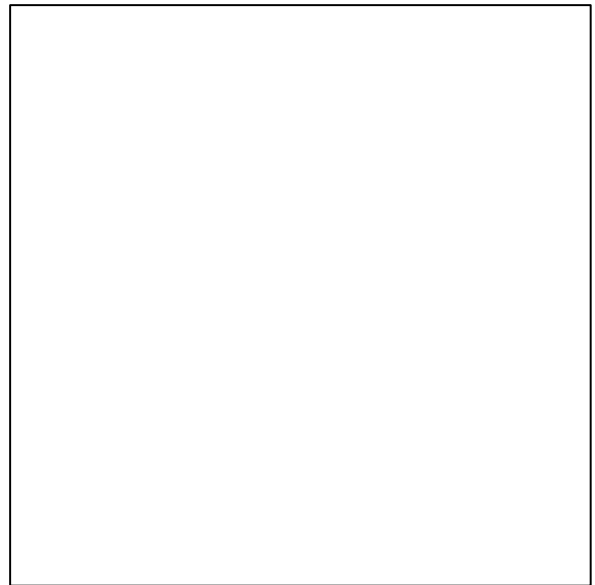

4b.

5. What is the difference between the oscilloscope patterns in 3 and 4 above?

6. Describe the AIC wave form for a speed sensor with a missing tooth.
