

## ***SECTION VII***

### **ADVANCED PARKING GUIDANCE SYSTEM**

#### **Advanced parking guidance system**

- [Advanced Parking Guidance System](#) 264

## Advanced parking guidance system —

The advanced parking guidance system helps back up parking by displaying a rear-view image in order to provide a reference for back up maneuvering, as well as automatically controlling the steering wheel when backing into a target parking position set on the screen. The system will not automatically back up or regulate speed.

The advanced parking guidance system is not an automatic parking system. It is a system to assist back up parking.

As the system only assists with parking in a set target parking position, there are times when the system will be unable to render this assistance, depending on factors such as road surface or vehicle condition, or the distance to the set target parking position.

Depending on the characteristics of the camera lens, the distance to or position of people or obstacles shown on the screen may differ slightly from actual conditions.

Vehicles with Lexus parking assist-sensors — when the Lexus parking assist-sensors are turned on and an obstacle is detected in front of or behind your vehicle, a warning appears on the right top of the screen. For details, see “*Owner’s Manual*”.

### SELECTING A LANGUAGE

See “Selecting a language” on page 175 for the procedure to select a language. Once you select a language, the advanced parking guidance system will indicate that language until you select another language.

### CAUTION

- Never depend on the advanced parking guidance system entirely when backing up. Always make sure your intended path is clear.

Use caution, just as you would when backing up any vehicle.

- Never back up while looking only at the screen. The image on the screen is different from actual conditions. Depicted distances between objects and flat surfaces will differ from actual distances. If you back up while looking only at the screen, you may hit a vehicle, a person or an object. When backing up, be sure to check behind and all around the vehicle visually and with mirrors before proceeding.
- Back up slowly, using the brake pedal to control the vehicle’s speed.
- If you seem likely to hit nearby vehicles, obstacles or people, depress the brake pedal to stop the vehicle, and then disable the system by touching  on the screen.
- Use the system for flat spaces.
- As the steering wheel moves automatically in the parallel parking assist mode and parking assist mode, be aware of the following points:
  - Keep clothing such as neckties, scarves and long sleeves away from the steering wheel, as they may become entangled. Also, keep children away from the steering wheel.
  - If you have long fingernails, be careful not to injure yourself when the steering wheel moves.

- If there is a problem, stop the vehicle and disable the system by touching  on the screen.
- Be sure to check that the vehicle can actually park in the target space before beginning operation.
- Do not use the system in the following conditions:
  - Out side of parking areas
  - In unprepared parking area such as gravel or sand
  - In parking areas that are crooked or have level variations
  - On slippery or icy roads, or in snow
  - If the asphalt is melted due to harsh sunlight
  - If there are obstacles in the target parking position (inside the green frame), or obstacles between the vehicle and the parking space
  - If there are a large number of vehicles or pedestrians passing
  - In areas unsuitable for parking (overly small parking space, cliff etc.)
  - If the image is hard to see due to dirt, direct sunlight, shadow or snow on the camera lens
  - If you are using tire chains or emergency tire(s)
- Do not use tires other than those installed by the manufacturer, as the system may not function correctly. Furthermore, if you change the tires, there may be errors in the positions of the lines and frames displayed on the screen. If you wish to change your tires, see your Lexus dealer .

- In the following conditions, assisted parking in the set parking position may not be possible:
  - The tires are extremely worn, or the tire inflation pressure is low
  - You are carrying an extremely heavy load
  - There is a load in one side of the vehicle only, causing the vehicle to lean
- Do not use the system when the trunk is not completely closed.
- If the back of the vehicle is hit, the position and mounting angle of the camera may change. Be sure to have the camera's position and mounting angle checked at your Lexus dealer.
- As the camera has a water proof construction, do not detach, disassemble or modify it. This may cause incorrect operation.
- If the temperature changes rapidly, such as when hot water is poured on the vehicle in cold weather, the system may not operate normally.
- If the camera lens becomes dirty, it cannot transmit a clear image. If water droplets, snow, or mud adhere to the lens, rinse with water and wipe with a soft cloth. If the lens is extremely dirty, wash it with a mild cleanser and rinse.
- If you scrape the camera cover, or scrub it with a hard brush or an abrasive agent, you may scratch the cover, leading to poor picture quality.
- Do not allow organic solvent, car wax, window cleaner or paint coating to adhere to the camera. If this happens, wipe it off as soon as possible.

- If the camera is subjected to a collision, or the camera orientation confirmation lines are not in line with the bumper, it is likely that the camera position or angle of installation has become crooked. See your Lexus dealer as soon as possible.
- Use your own eyes to confirm the vehicle's surroundings, as the displayed image may become faint or dark, and moving images will be distorted, or not entirely visible when the outside temperature is low. When backing up, be sure to check behind and all around the vehicle visually and with mirror before proceeding.

- **Area displayed on screen**  
Image is displayed approximately level on screen.

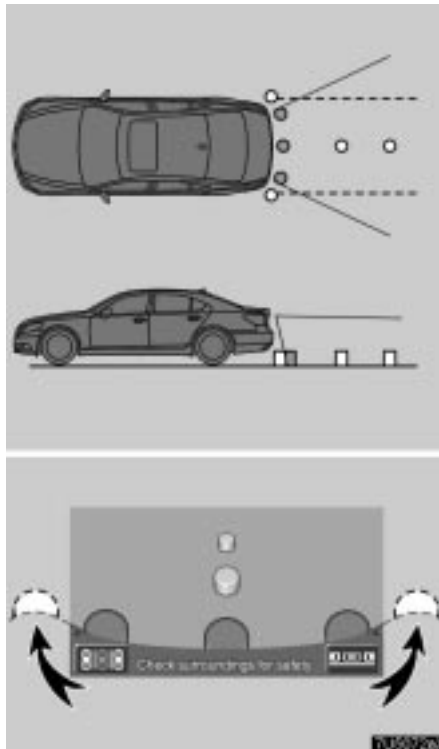

► **Corners of bumper**

The area covered by the camera is limited. Objects which are close to either corner of the bumper or under the bumper cannot be seen on the screen.

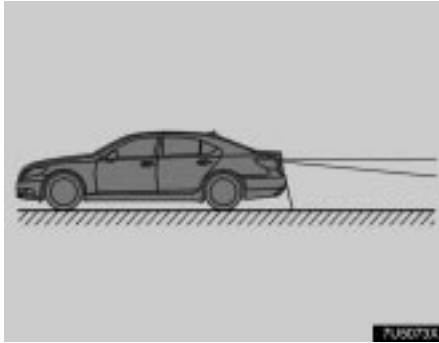

The area displayed on the screen may vary according to vehicle orientation or road conditions.

- The advanced parking guidance system



The advanced parking guidance system camera is located on the trunk as shown in the illustration.

The camera uses a special lens. The distance of the image that appears on the screen differs from the actual distance.

In the following cases, it may become difficult to see the images on the screen, even when the system is functioning.

- In the dark (for example, at night)
- When the temperature near the lens is extremely high or low
- When water droplets are adhering to the camera, or when humidity is high (for example, when it rains)
- When foreign matter (for example, snow or mud) adheres to the camera lens
- When the camera has scratches or dirt on it
- When the sun or the beam of headlights is shining directly into the camera lens

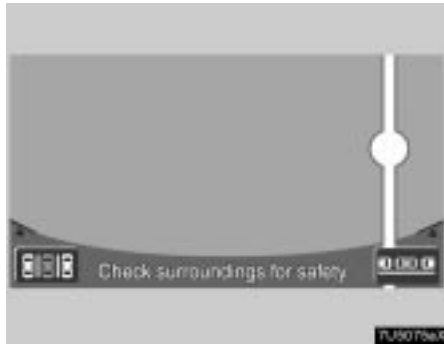

If a bright light (for example, sunlight reflected off the vehicle body) is picked up by the camera, the smear effect\*, peculiar to the CCD camera, may occur.

\*: Smear effect—A phenomenon that occurs when a bright light (for example, sunlight reflected off the vehicle body) is picked up by the camera; when transmitted by the camera, the light source appears to have a vertical streak above and below it.

If you install the antenna of a wireless device close to the camera, the screen image may be affected by the electromagnetic waves, and the system may not function correctly. Install an antenna away from the camera.

The method for adjusting the picture quality of the advanced parking guidance system is the same as that for the navigation screen.

### —Maneuvering when parking

Instructions given are only examples. When and how much to turn the steering wheel will vary according to traffic conditions, road surface conditions, vehicle condition, etc. when parking.

It is necessary to be fully aware of this before using the advanced parking guidance system.

Also, when parking, be sure to check that the parking space will accommodate your vehicle before maneuvering into it.

#### CAUTION

Depending on the circumstances of the vehicle (number of passengers, amount of luggage, etc.), the set target parking position displayed on the screen may change. Be sure to check visually behind and all around the vehicle before proceeding.

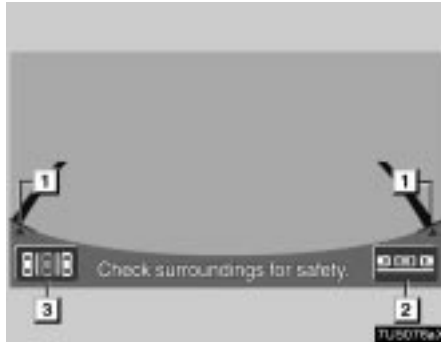
**(a) To activate the advanced parking guidance system**

**To activate the advanced parking guidance system, place the selector lever in “R” position when the engine switch is in “IG-ON” mode.**

- If you move the selector lever out of “R” position, the screen returns to the previous screen. Operating another function of the navigation system will display another screen.
- Even if the selector lever is in “R” position, if you push any of the mode buttons around the display, such as “MAP/VOICE” or “INFO”, the screen will switch to that mode.

**1 Camera orientation confirmation lines**

If the edge of the bumper displayed on the screen does not match the camera orientation confirmation lines, the camera may not be aligned correctly. Have the vehicle checked by your Lexus dealer.

**2 Parallel parking assist mode button**

Touching this button turns parallel parking assist mode on.

See “ — Parallel parking assist mode” on page 273 for details.

**3 Parking assist mode button**

Touching this button turns parking assist mode on.

See “ — Parking assist mode” on page 282 for details.

- To adjust the volume of the voice guidance, ask your Lexus dealer for details.

**(b) Disabling the advanced parking guidance system**

**When in the parking assist mode or parallel parking assist mode, in the following case the voice guidance will say “The guidance has been cancelled”, a message will be displayed, and the system will be disabled. For displayed message, see page 292.**

**After the following operations**

- Moving the steering wheel
- Using the accelerator
- Moving the selector lever out of “R” position
- Applying the parking brake
- Switching the screen display

**In the following situation**

- If the vehicle slips forward or stops after taking your foot off the brake pedal
- If the backing speed is too fast
- If normal assistance cannot be rendered due to worn tires or low tire inflation pressure
- If the target parking position has not been confirmed on the target parking position setting screen before backing up
- Any warnings displayed on the screen are not acknowledged before backing up
- If there is a system malfunction

If the system is disabled while backing up, grip the steering wheel firmly and depress the brake pedal to bring the vehicle to a halt. The system has been completely disabled, so you may either start again from the beginning, or if you wish to finish parking manually, be sure to operate the steering wheel as you would normally.

If a hands-free phone call is received, the hands-free screen will be displayed, and the system will be disabled.



### —Driving precautions

In any of the following situations, there is a margin of error between the set target parking position on the screen and the actual distance/course on the road.

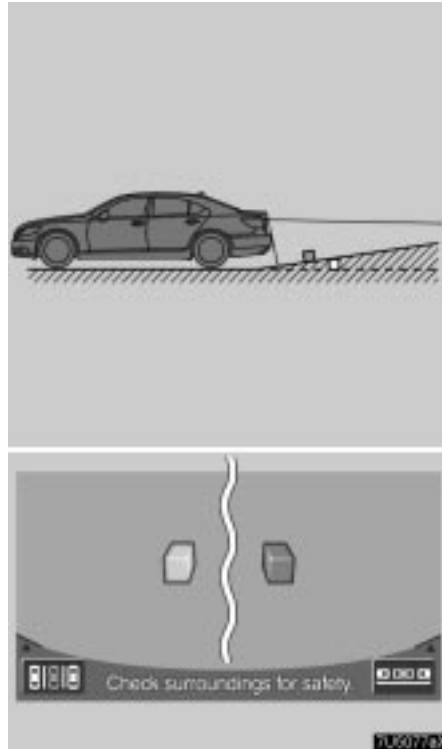

- When the grade behind the vehicle slopes up sharply, objects appear to be farther away than they actually are.

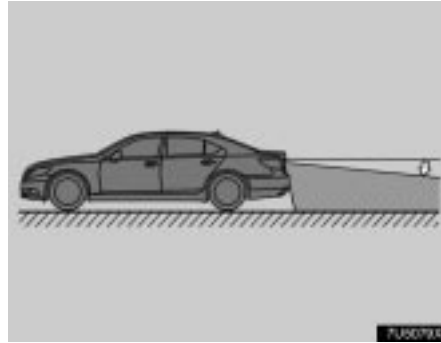
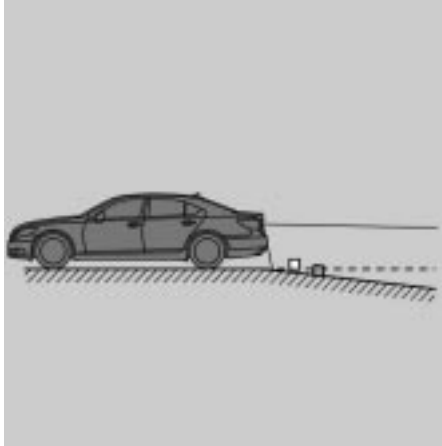

- When any part of the vehicle sags due to the number of passengers or the distribution of the load, there is a margin of error between the set target parking position on the screen and the actual distance/course on the road.

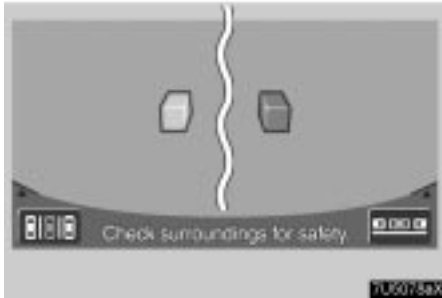

- When the grade behind the vehicle slopes down sharply, objects appear to be closer than they actually are.

## — Parallel parking assist mode

Parallel parking assist mode assists the driver with parallel parking by automatically controlling the steering wheel when backing up, in order to park in the target position set on the screen.

**⚠ CAUTION**

- When backing up, be sure to check your surroundings and behind the vehicle for safety, and back up slowly, depressing the brake pedal to control vehicle speed.
- If you seem likely to hit nearby vehicles, obstacles or people, depress the brake pedal to stop the vehicle, then disable the system by touching  on the screen.

As the system only assists with parking in a set target parking position, there are times when the system will be unable to render this assistance, depending on factors such as road surface or vehicle condition, or the distance to the set target parking position.

Use the system with full understanding of the fact.

If a message is displayed while maneuvering, follow the procedures outlined in “ — What to do when this sort of message is displayed” on page 292.

The illustrations here describe the procedure for pulling into a parking space on the right. For pulling into a parking space on the left, substitute left for right and vice versa in all steps.

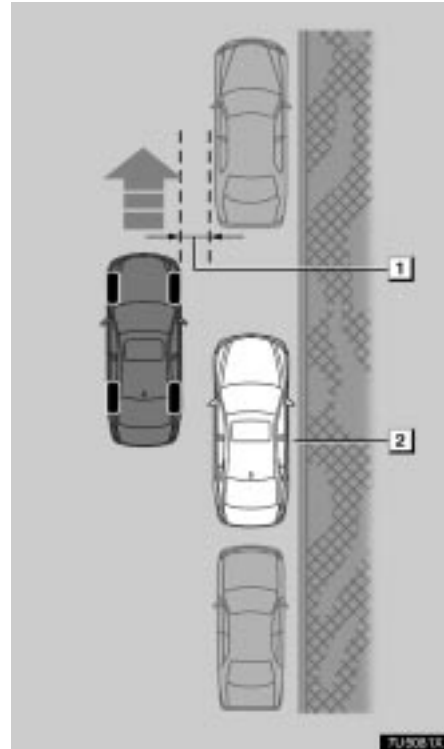

- ▶ **1** Approx. 3 ft. (1 m)
- ▶ **2** Desired parking location

1. Move your vehicle slowly to a position parallel to the road or shoulder approximately 3 ft. (1 m) away from parked vehicles.

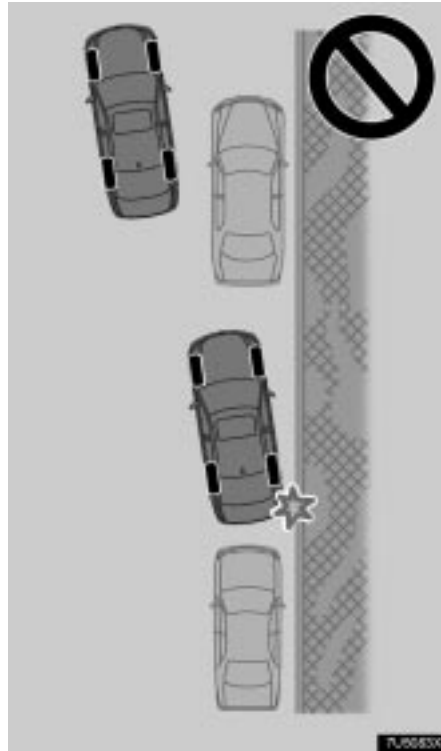
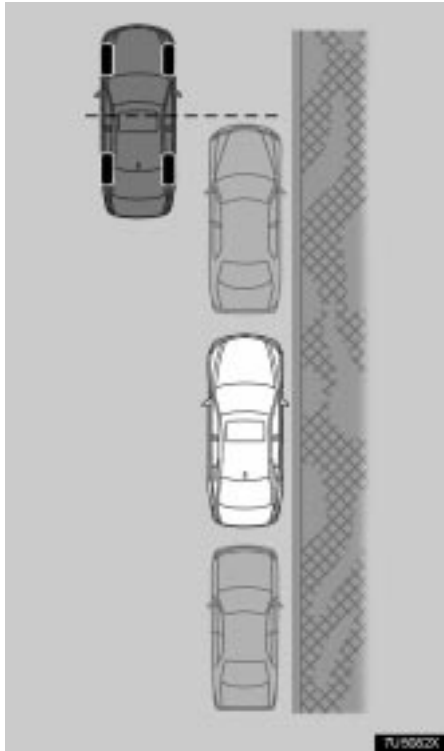

2. Stop your vehicle in a position where you can see the front edge of the leading parked vehicle right beside you, with the steering wheel straight.

**⚠ CAUTION**

Be sure to stop the vehicle parallel to the road or shoulder. If the vehicle is not parallel, the assist location will be very near the shoulder. If it looks like the vehicle will hit or mount the shoulder, depress the brake pedal to stop the vehicle, and touch  on the screen to deactivate the system.

If there is no leading parked vehicle, the system will display the target parking position (green or red frame) in the position used last time the parallel parking assist mode was activated.

3. Place the selector lever in the “R” position.



4. Touch **OK** on the screen.



5. Use the arrow to align the green frame with your target parking space, and touch “OK”.

You can also move the green frame by touching the screen (area other than the arrows).

There are tricks to align the green frame. See “Tips for setting the target parking position” on page 279.

If the frame is displayed in red, you cannot use the parallel parking assist mode to park in that location. See “When a red frame is displayed in the assist mode” on page 295.

## 276      **ADVANCED PARKING GUIDANCE SYSTEM**

When the green frame is displayed, if you begin backing up without touching “OK”, the message “Parking position has not been set.” appears. If you continue to back up, you will hear a warning tone and the system will be disabled.

If the frame is red, there will be no guidance even if you begin backing up.

If the orientation of the frame is opposite to that of the target parking space, touch



There may be times when, due to image distortion, the green frame does not match the parking space lines on the road surface. In this case, use the warning flag and green extension guide line to set the target parking position.

You may adjust the target parking position even after starting the parallel parking assist mode.

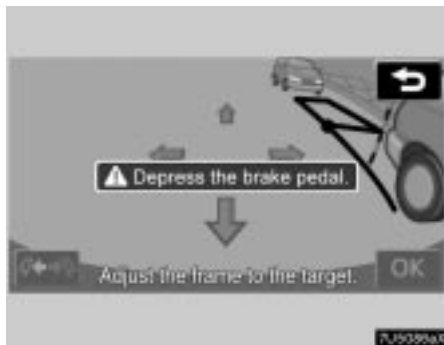

This screen will be displayed when “OK” is touched while the brake hold system is on.

Depress the brake pedal and touch “OK”.



### **CAUTION**

- Always check that there are no obstacles in the green frame or between your vehicle and the parking space, and that the warning flag and extension guide line do not overlap any parked vehicles or walls.
- If there are obstacles in the green frame or between your vehicle and the parking space, or the warning flag or extension guide line overlaps a parked vehicle or wall, there is a danger of collision. In this case, do not use the parallel parking assist mode. The same applies if the green frame overlaps the shoulder.
- If the road surface has level variations or a gradient, it will not be possible to correctly set the location. In this case, do not use the parallel parking assist mode.

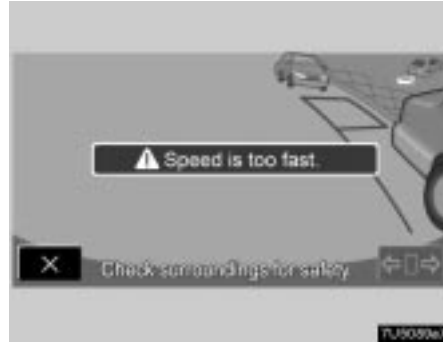
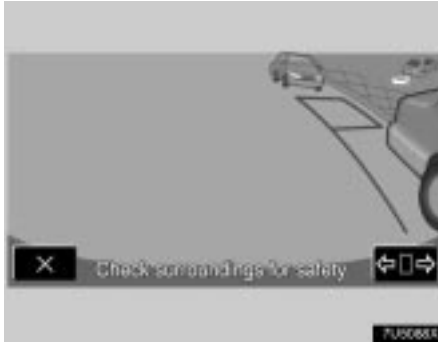

6. Position yourself as you would when backing up normally, and rest your hands on the steering wheel without applying any pressure. Check your surroundings and behind the vehicle for safety, and slowly back up, using the brake pedal to control the vehicle's speed.

If you touch , assistance is cancelled.

If the vehicle's backing up speed is too fast, a warning tone will sound. If you continue to back up at that speed, the system will be disabled. Back up at a speed that does not cause the warning tone to sound.

The green frame displayed on the screen is approximately the same size as your vehicle. (The green frame displayed when setting the target parking position is the size of a normal parking space.)

## 278      ADVANCED PARKING GUIDANCE SYSTEM

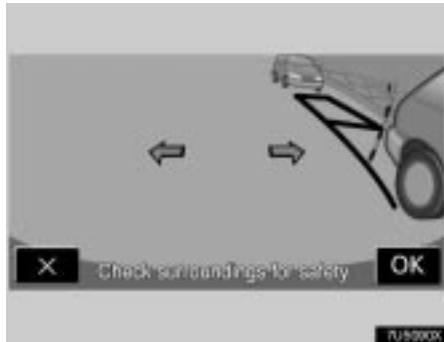

You can change the target parking position by touching . If you are backing up, or have already moved close to the target parking position, will turn gray, and you will be unable to change the target.

Touch the arrows to move the target parking position, and then touch "OK".

You can only move the target parking position left or right, and the warning flag will not move even if you adjust the target parking position.

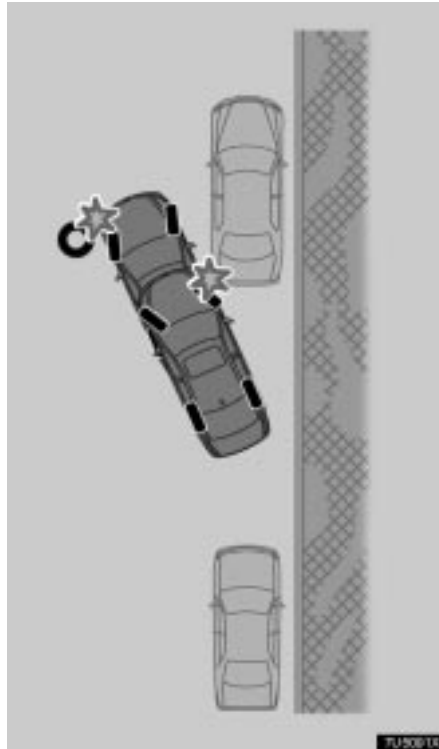

### CAUTION

- When backing up, be sure to check your surroundings and behind the vehicle for safety, and back up slowly, depressing the brake pedal to control vehicle speed.
- If a collision seems likely, depress the brake pedal to stop the vehicle, then disable the system by touching on the screen.



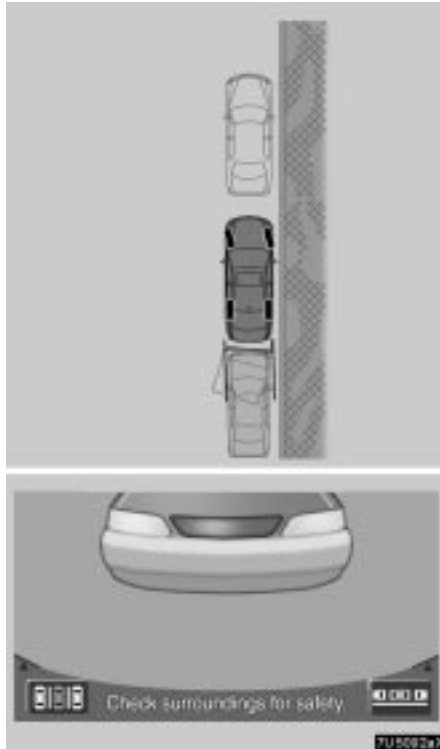

- **Tips for setting the target parking position**

Useful information for setting the target parking position (green frame)

- **ALIGNING THE GREEN FRAME**

There are two ways to align the green frame with the parking space, either using the arrows on the screen, or by touching the screen at points other than the arrows.

7. Once the vehicle is mostly within the target parking position, voice guidance will give the message "The guidance is finished", and parallel parking assist mode will finish.

For safety, voice guidance is given slightly before the target parking position. Furthermore, at that point system control will finish, so grip the steering wheel firmly, and finish parking in the desired position, using the brake to control the vehicle's speed.

Check in front and behind the vehicle visually and check with the mirrors while backing up.

**Using the arrows on the screen**

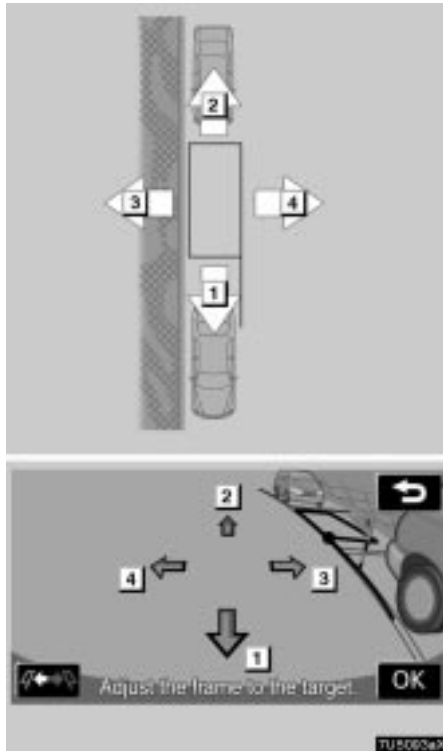

By touching the arrows displayed on the screen, you can move the green frame.  
Adjusting the left-right alignment first will make subsequent alignment easier.

**Directly touching the target point**

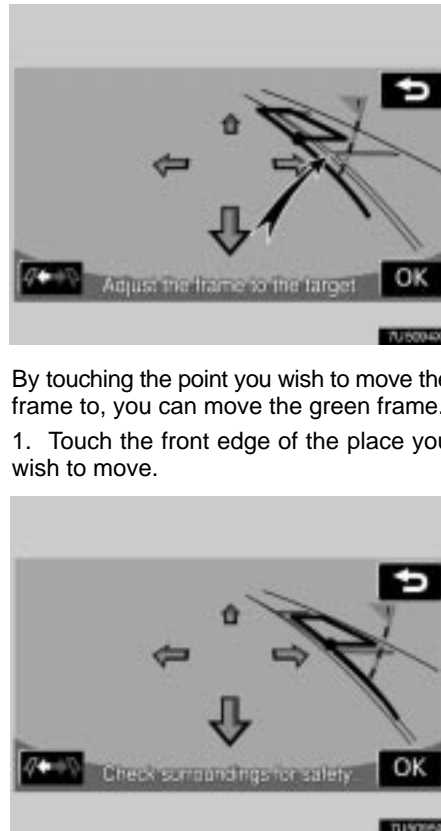

By touching the point you wish to move the frame to, you can move the green frame.  
1. Touch the front edge of the place you wish to move.

2. The frame will be moved as shown.
- If you touch the following areas, the green frame will not move:
- The area surrounding the arrows.
  - The area near the lower touch-screen button on the screen.
  - Areas too far away to park in the range of 34.4 ft. (10.5 m) or more behind the current position, and/or 16.4 ft. (5.0 m) or more either left or right from the current position.

**IF THERE IS A SLOPE IN THE ROAD**

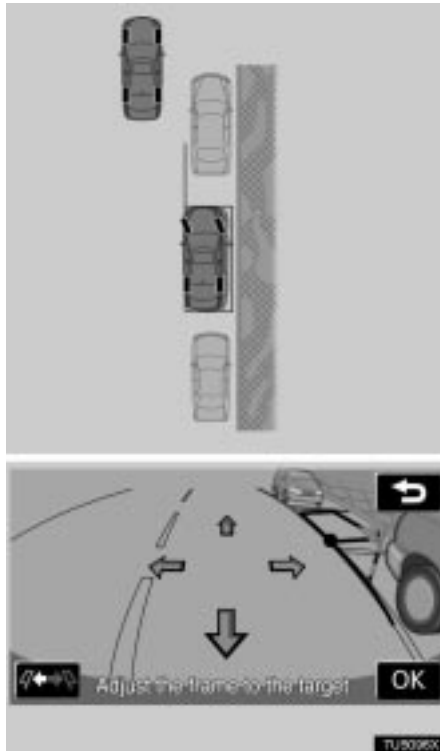

The assisted parking position will be closer to the middle of the road (further from the shoulder) than the set target parking position.

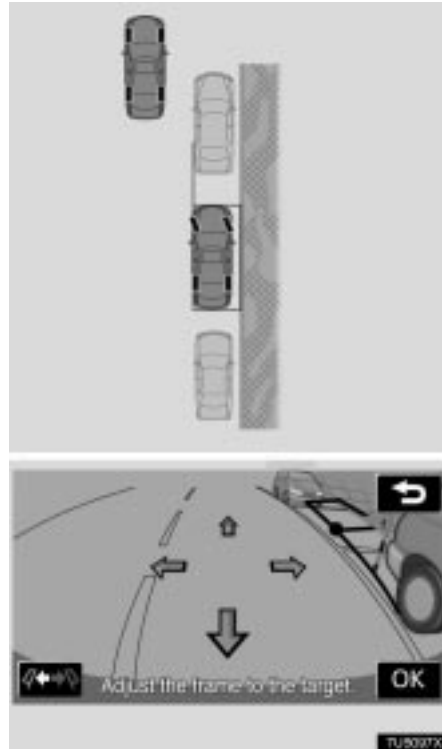

In this case, if you align the warning flag with the rear of the forward parked vehicle, and the green extension guide line with the lower edge of the parked vehicle's rear wheel when setting the target parking position, the left side of your vehicle will be roughly in line with the left side of the front parked vehicle once assisted parking is complete. If you are parallel parking on the opposite side of the road, left and right will be reversed.

### — Parking assist mode (Perpendicular parking)

Parking assist mode assists the driver with perpendicular parking by automatically controlling the steering wheel when backing up, in order to park in the target position set on the screen.

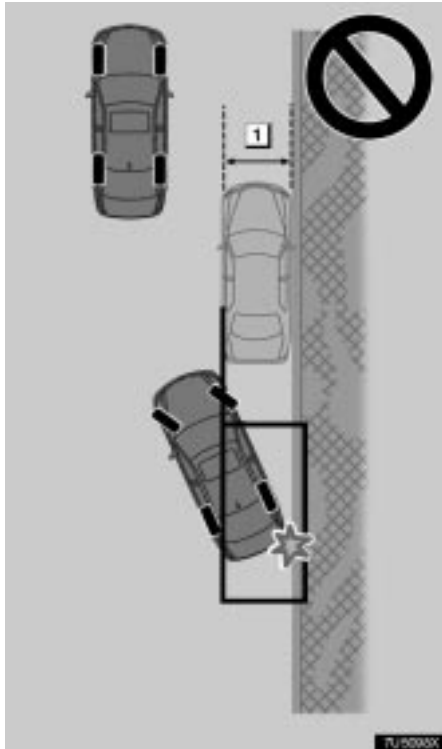

▶ **1** Narrow

#### **! CAUTION**

If the parked vehicle is narrow, or parked close to the shoulder, the assisted parking position may be quite close to the shoulder. If the vehicle seems likely to hit or mount the shoulder, depress the brake pedal to stop the vehicle, and disable the system by touching .

#### **! CAUTION**

- When backing up, be sure to check your surroundings and behind the vehicle for safety, and back up slowly, depressing the brake pedal to control vehicle speed.
- If you seem likely to hit nearby vehicles, obstacles or people, depress the brake pedal to stop the vehicle, then disable the system by touching  on the screen.

As the system only assists with parking in a set target parking position, there are times when the system will be unable to render this assistance, depending on factors such as road surface or vehicle condition, or the distance to the set target parking position.

Use the system with full understanding of the fact.

If a message is displayed while maneuvering, follow the procedures outlined in “— What to do when this sort of message is displayed” on page 292.

The illustrations here describe the procedure for pulling into a parking space on the left. For pulling into a parking space on the right, substitute right for left and vice versa in all steps.

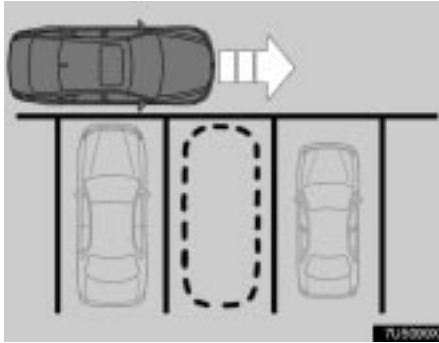

1. Move your vehicle slowly to a position perpendicular to the parking space, and as close as possible to the parking space.

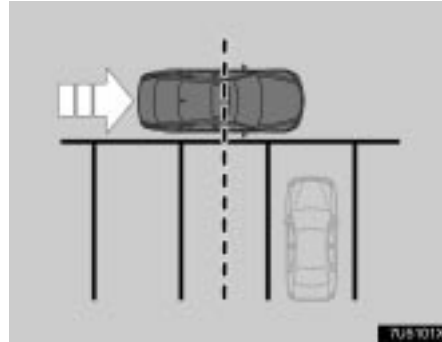

If no vehicle or small vehicles are parked on both sides of the desired parking space, stop with the steering wheel straight.

By stopping the vehicle here, you can mostly identify the parking location, making it easier to set the target parking position.

Make sure the steering wheel is straight when you stop. If not, the parking location cannot be identified.

If you do not stop in front of the parking space, the system will refer to the angle of the vehicle relative to the target parking space, and display the target parking position (green or red frame) in the position used last time the parking assist mode was activated.

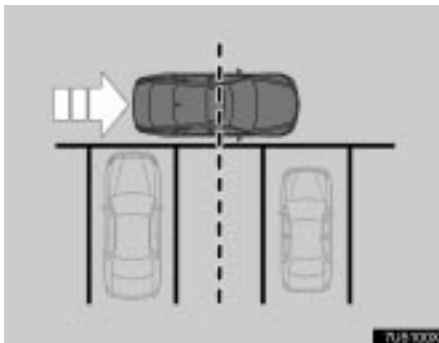

2. Move your vehicle to a position where you can see the center of the parking space right besides you.

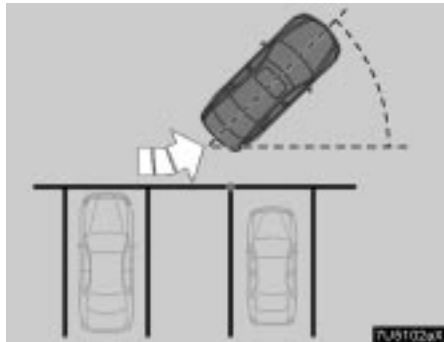

3. Position your vehicle so that you can enter the parking space, then stop the vehicle with the steering wheel straight.

If no vehicle or small vehicles are parked on both sides of the parking space and you do not stop in front of the parking space, position your vehicle with a larger heading angle.

4. Place the selector lever in the "R" position.



5. Touch **D+R** on the screen.

6. Use the arrow to align the green frame with the desired parking space, then touch "OK".

You can also move the green frame by touching the screen (area other than the arrow).

There are tricks to align the green frame.

See "Tips for setting the target parking position" on page 289.

Areas in which you are unable to park are displayed in red.

If the frame is displayed in red, you cannot use the parking assist mode to park in that location. See "When a red frame is displayed in the assist mode" on page 295.

When the green frame is displayed, if you begin backing up without touching "OK", the message "Parking position has not been set." appears. If you continue to back up, you will hear a warning tone and the system will be disabled.

If the frame is red, there will be no guidance even if you begin backing up.

If the orientation of the frame is opposite to that of the target parking space, touch



There may be times when, due to image distortion, the green frame does not match the parking space lines on the road surface. In this case, attempt an approximate match in an area where the warning flag does not overlap with any parked vehicles or obstacles.

You may adjust the target parking position even after starting the parking assist mode.



This screen will be displayed when “OK” is touched while the brake hold system is on.

Depress the brake pedal and touch “OK”.



### CAUTION

- Always check that there are no obstacles in the green frame or between your vehicle and the parking space, and that the warning flag does not overlap any parked vehicles or walls.
- If there are obstacles in the green frame or between your vehicle and the parking space, or the warning flag overlaps a parked vehicle or wall, there is a danger of collision. In this case, do not use the parking assist mode.
- If the road surface has level variations or a gradient, it will not be possible to correctly set the location. In this case, do not use the parking assist mode.
- If the red area which denotes an area unsuitable for parking overlaps with the lines of the parking space, you will be unable to park, as the parking space is judged as being an area unsuitable for parking. Progress to a position where the parking space lines do not overlap with such an area.

7. Position yourself as you would when backing up normally, and rest your hands on the steering wheel without applying any pressure. Check your surroundings and behind the vehicle for safety, and slowly back up, using the brake pedal to control the vehicle's speed.



If you touch , assistance is cancelled.





If the vehicle's backing up speed is too fast, a warning tone will sound. If you continue to back up at that speed, the system will be disabled. Back up at a speed that does not cause the warning tone to sound. The green frame displayed on the screen is approximately the same size as your vehicle. (The green frame displayed when setting the target parking position is the size of a normal parking space.)



You can change the target parking position by touching . If you are backing up, or have already moved to close to the target parking position,  will turn gray, and you will be unable to change the target.

Touch the arrows to move the target parking position, and then touch "OK".



**CAUTION**

- When backing up, be sure to check your surroundings and behind the vehicle for safety, and back up slowly, depressing the brake pedal to control vehicle speed.
- If you seem likely to hit nearby vehicles, obstacles or people, depress the brake pedal to stop the vehicle, then disable the system by touching  on the screen.

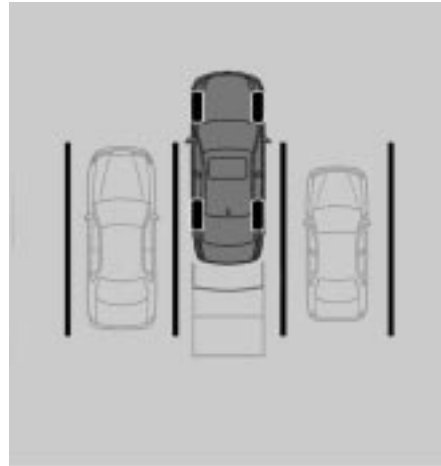

8. Once the vehicle is mostly within the target parking position, voice guidance will give the message "The guidance is finished" and parking assist mode will finish.

For safety, voice guidance is given slightly before the target parking position. Furthermore, at that point system control will finish, so grip the steering wheel firmly, and finish parking in the desired position, using the brake to control the vehicle's speed.

Check in front and behind the vehicle visually and check with the mirrors while backing up.

- **Tips for setting the target parking position**

Useful information for setting the target parking position (green frame)

#### **THE DISPLAY POSITION OF THE GREEN FRAME**

The system decides the initial positioning of the green frame by the position of the vehicle when it stops, and by detecting the white lines of the parking space in the camera image to identify the parking space location.

When the vehicle stops, the parking space location is mostly identified, and the white lines in that location are detected. For this reason, stopping in front of the parking space will make the detection of target parking space's white lines easier.

Successful detection of the parking space's white lines may not be possible, depending on the shape of the line.

#### **In the following circumstances, detection of the parking space lines on the road surface may not be possible:**

- The lines are faded or dirty, making them unclear.
- The road surface is of a light color which does not contrast well with the white lines.
- The parking space lines are a color other than white (yellow etc.).
- The area is dark, for example at night or in a covered parking lot.
- During or after rain, when the road surface is wet and reflects light, or puddles have formed.
- The sun is shining directly on the camera, for example early morning or late afternoon.
- The parking space is covered with snow or de-icing agent.
- There are markings or maintenance marks on the road surface.

- The color or brightness of the road surface is not uniform.
- Hot or cold water has splashed on the camera, and the lens is fogged.
- There are dirt or water droplets on the lens.

If the point at which you stop is correctly identified, the green frame will display the parking space accurately. If the white lines of the parking space have not been correctly identified, the green frame will not match the parking space even if you stop in the correct location. In this case, adjust the point at which you stop as needed.

**ALIGNING THE GREEN FRAME**

There are two ways to align the green frame with the parking space, either using the arrows on the screen, or by touching the screen at points other than the arrows.

**Using the arrows on the screen**

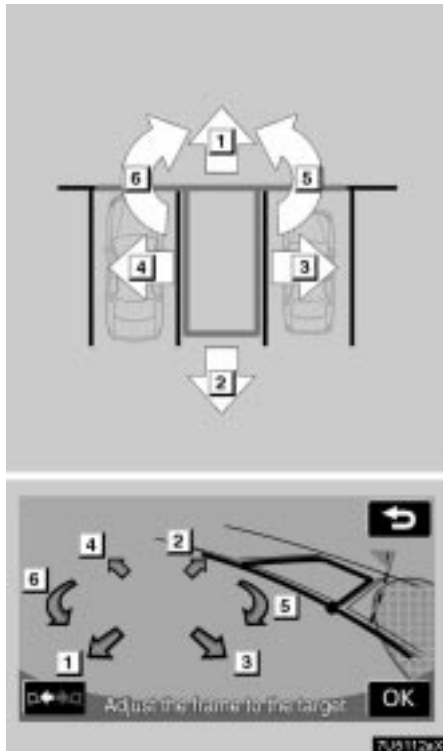

By touching the arrows displayed on the screen, you can move the green frame.

**Directly touching the target point**



By touching the point you wish to move the frame to, you can move the green frame.

1. Touch the front edge of the place you wish to move.



2. The frame will be moved as shown.

If you touch the following areas, the green frame will not move:

- The area surrounding the arrows.
- The area near the lower touch-screen button on the screen.
- Areas too far away to park in the range of 31.2 ft. (9.5 m) or more behind, and/or either left or right from the current position.

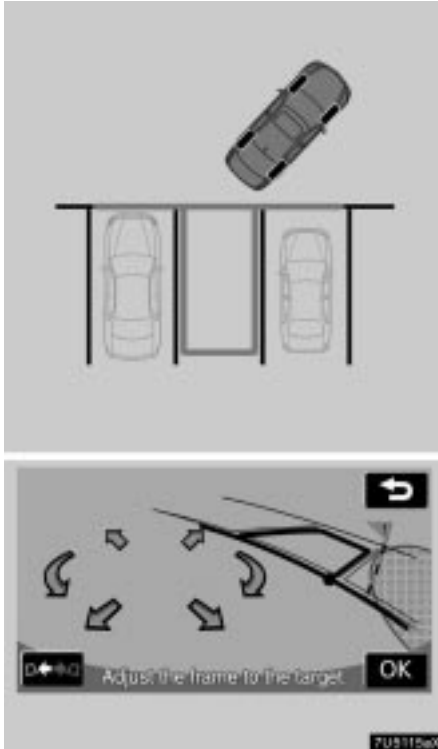
**IF THE PARKING SPACE AND THE GREEN FRAME DO NOT MATCH**

If the lines of the parking space are wider than the green frame, position the frame so that the difference between the frame and the parking space lines is equal on both sides.

**— What to do when this sort of message is displayed**

Message	Cause	What to do
! Parking position cannot be set.	Not in an area where system use is possible.	Change the vehicle's position, referring to the help function.
! Check APGS system. Have your vehicle check by a dealer.	There is a malfunction in the system.	Have your vehicle checked by your Lexus dealer.
! Use on flat surface.	<ul style="list-style-type: none"> <li>● The vehicle has rolled forward on a sloped road.</li> <li>● The vehicle does not move even if you take your foot off the brake pedal.</li> </ul>	Do not attempt to use the system in those sort of conditions.
! System cannot guide under current conditions.	If the message is displayed only when the system is operating, it is likely that the tires are worn, or tire inflation pressure is low.	Check tires for wear and pressure.
	If the message is displayed constantly, there is most likely a malfunction.	Press the engine switch to "IG-OFF" mode, then restart it. If the message is still displayed, have the vehicle checked by your Lexus dealer.
	The vehicle has skidded or the tires have been locked.	Do not attempt to use the system on a slippery road such as snowy road.
! APGS not available now.	The system has temporarily overheated.	Press the engine switch to "IG-OFF" mode, then restart it. Wait a few moments before use.
! Release parking brake.	The parking brake has been applied.	Release the parking brake.
! Too much force applied to the steering wheel.	You are exerting too much pressure on the steering wheel.	Loosen your grip on the steering wheel.
Steering position is not neutral. Turn the steering wheel to left (or right).	The steering wheel is not straight.	Straighten the steering wheel.

Message	Cause	What to do
Steer to left (or right) until the frame becomes green.	It is possible to begin to park if you turn the steering wheel in the direction indicated.	Turn the steering wheel in the direction indicated until the frame turns green (the message "Too much force applied to the steering wheel" is displayed). Turn the wheel slightly more than necessary to overcome tire resistance. Once you have turned the steering wheel, you can no longer change the target parking position. Be sure to align the frame before turning the steering wheel.
! Parking position has not been set.	You have begun to back up without touching "OK".	Stop the vehicle and touch "OK".
! Speed is too fast.	The speed at which you are backing up is too fast.	Back up at a speed that does not cause the warning chime to sound, using the brake pedal. The system will be disabled if you back up too quickly.
! Guidance cancelled by user operation.	You have turned the steering wheel during the assist mode.	The system has been disabled, so restart from the beginning.
! Accelerator pedal has been depressed.	You have depressed the accelerator pedal during the assist mode.	The system has been disabled, so restart from the beginning.
! Guidance unavailable	Some sort of malfunction has occurred within the system.	Have the vehicle checked by your Lexus dealer.
! System not ready	-	Take your vehicle to your Lexus dealer.
! Depress the brake pedal.	"OK" is touched while the brake pedal system is on.	Depress the brake pedal and touch "OK".
! Check Park Sonar	In extreme cold weather or foreign matter gets on the sensors.	Have the vehicle checked by your Lexus dealer.

**294      ADVANCED PARKING GUIDANCE SYSTEM**

---

**Message and voice guidance**

In the parallel parking assist mode and parking assist mode, voice guidance accompanies the following messages displayed during parking position setting and steering wheel control. (Voice guidance may not be given depending on the reason the message was displayed.)

Message	Voice Guidance (Warning tone)	
	During setting	During steering wheel control
! Check APGS system. Have your vehicle check by a dealer.	(One chime)	(Two beeps) The assist has been cancelled.
! System cannot guide under current conditions.	-	(One beep) The assist has been cancelled.
! APGS not available now.	(One chime)	(One beep) The assist has been cancelled.
! Release parking brake.	(One chime)	(One beep) The assist has been cancelled.
! Parking position has not been set.	(One chime)	-
! Speed is too fast.	-	(Two beeps and then one beep) The assist has been cancelled.
! Guidance cancelled by user operation.	-	(One beep) The assist has been cancelled.

For the adjustment of the volume, ask your Lexus dealer.



- **When a red frame is displayed in the assist mode**

If the frame turns red and the message "Adjust the frame to the target" is displayed while setting the target parking position, you cannot use the assist mode.

In this situation, move the target parking position, or move the position of the vehicle.

The frame may be displayed in red, depending on the location and angle of the vehicle when "R" is selected.

Furthermore, even if the frame is displayed in green, if you move the frame to a location unsuitable for parking using the assist mode, the frame will change to red.

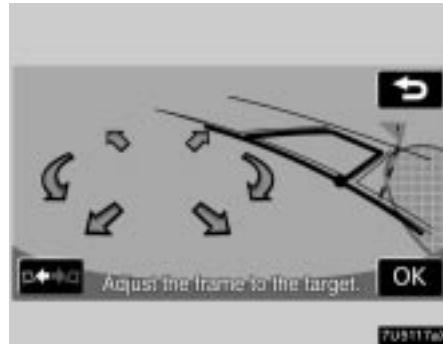

When in the parking assist mode, if the message "Steer to right (of left) until the frame becomes green." is displayed, you may use the assist mode by turning the steering wheel.

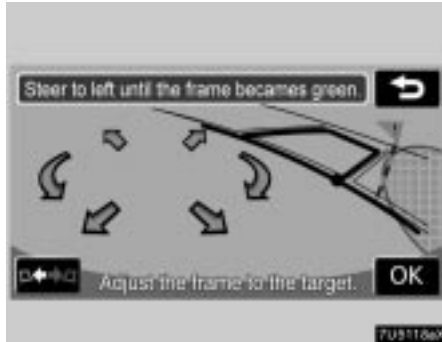

1. Align the frame with the target parking position.
2. While stopped, turn the wheel to the left (right) until the frame turns green and "Too much force applied to the steering wheel" is displayed.

Turn the wheel slightly more than necessary to overcome tire resistance.

If you turn the wheel too far, the direction of turn displayed on the screen will reverse.



3. Touch "OK".

Once you have turned the steering wheel, you can no longer change the target parking position. Be sure to align the frame before turning the steering wheel.

#### HELP FUNCTION

If you touch "OK", the reason the frame is displayed in red will be displayed. Move the vehicle appropriately, referring to the screen.

1. Touch "OK".
2. Move the vehicle in accordance with the message displayed.

See the following items for information on the messages displayed.

If you move the frame to a position acceptable to the assist mode, a chime will sound.

3. If you have moved the vehicle forwards, place the selector lever in the "R" position.



4. Check that the frame is green, and if that position is acceptable, touch "OK".

**DISPLAYED MESSAGE AND VEHICLE POSITION FOR PARKING ASSIST MODE**

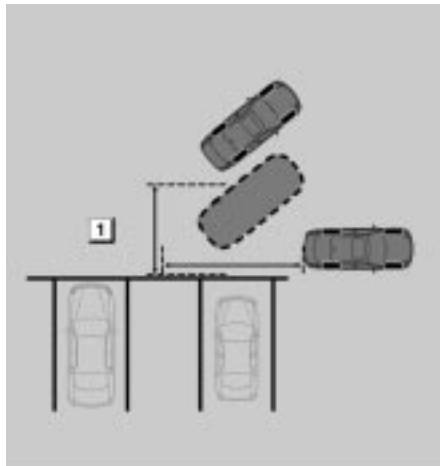

▶ **1 Too far**

If the vehicle is too far from the parking space

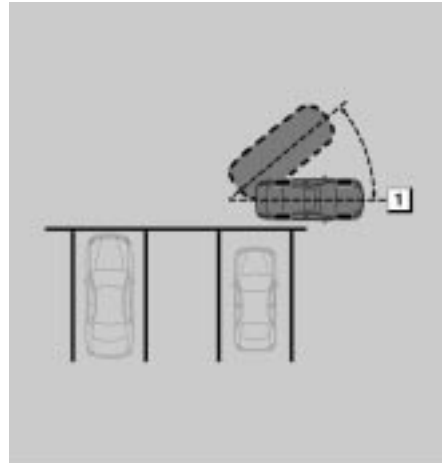

▶ **1 Angle too small**

If the orientation of the vehicle is incorrect

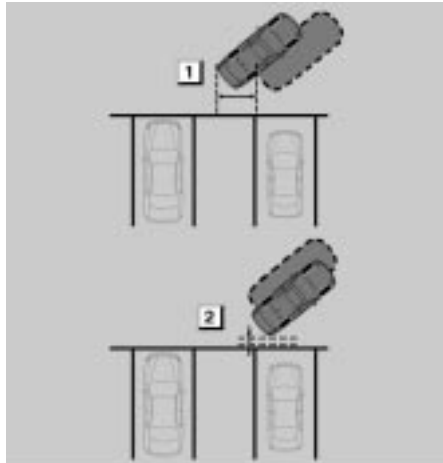

- ▶ **1** Near the front of the parking space
- ▶ **2** Too close

If the vehicle is near the front of the parking space, or too close

**DISPLAYED MESSAGE AND VEHICLE POSITION FOR PARALLEL PARKING ASSIST MODE**

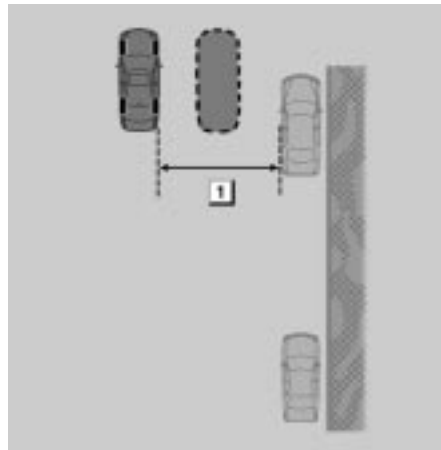

- ▶ **1** Too far

If the vehicle is too far from the parking space

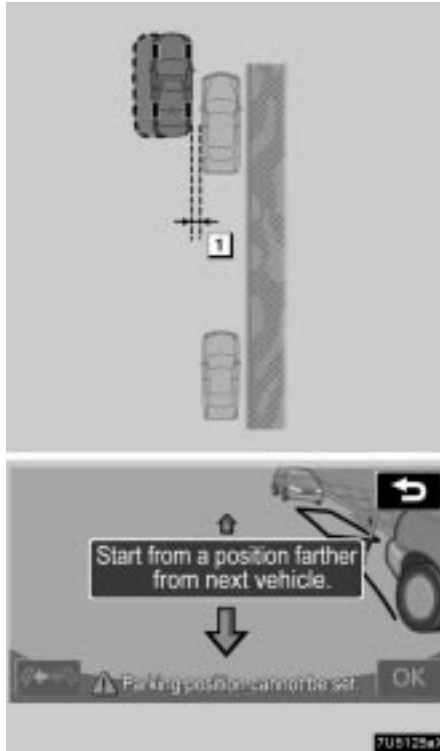

► **1 Too close**

If the vehicle is too close to other parked vehicles

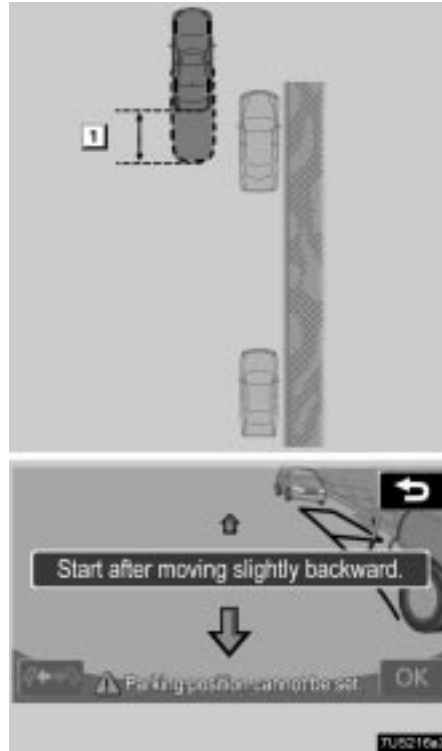

► **1 Too far forward**

If the vehicle is too far forward

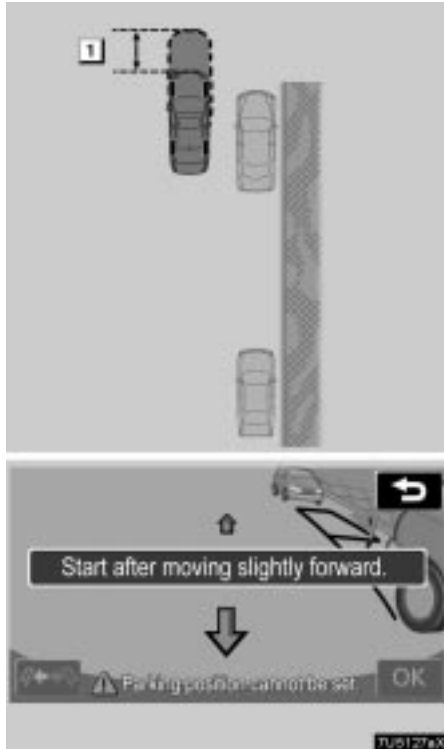
**— Initializing the system**▶ **1 Too far back****How to correct**

When the battery is disconnected and reconnected or when battery performance deteriorates, etc., the message “System initializing” will be displayed on the screen. The help screen appears when **?** is touched. Make a correction using the following method in accordance with the display.

When the vehicle is stopped, turn the steering wheel all the way to the left, then all the way to the right. (It does not matter in which direction—right or left—you turn first.)

When the screen returns to the original display, correction is complete.

If the above screen remains, have the vehicle inspected at your Lexus dealer.