

Preparation

Part Number: PTR02-53080

Kit Contents:

Item #	Quantity Req'd.	Description
1	1	Rear Sway Bar
2	2	Bushings
3		

Hardware Bag Contents

Item #	Quantity Req'd.	Description
1		
2		
3		

Additional Items Required For Installation

Item #	Quantity Req'd.	Description
1		
2		
3		

Conflicts

--

Recommended Tools

Personal & Vehicle Protection	Notes
Special Tools	Notes
Installation Tools	Notes
Special Chemicals	Notes

General Applicability

IS 250 AWD





Recommended Sequence of Application

Item #	Accessory
1	
2	

Vehicle Service Parts (may be required for reassembly)

Item #	Quantity Req'd.	Description
1		
2		
3		

Legend

	STOP: Damage to the vehicle may occur. Do not proceed until process has been complied with.
	OPERATOR SAFETY: Use caution to avoid risk of injury.
	CAUTION: A process that must be carefully observed in order to reduce the risk of damage to the accessory/vehicle and to ensure a quality installation.
	TOOLS & EQUIPMENT: Used in Figures calls out the specific tools and equipment recommended for this process.
	REVISION MARK: This mark highlights a change in installation with respect to previous issue.

Care must be taken when installing this accessory to ensure damage does not occur to the vehicle. The installation of this accessory should follow approved guidelines to ensure a quality installation

These guidelines can be found in the "Accessory Installation Practices" document.

This document covers such items as:

- Vehicle Protection (use of covers and blankets, cleaning chemicals, etc.).
- Safety (eye protection, rechecking torque procedure, etc.).
- Vehicle Disassembly/Reassembly (panel removal, part storage, etc.).
- Electrical Component Disassembly/Reassembly (battery disconnection, connector removal, etc.).

1. Remove Rear Sway Bar.

(a) Disconnect sway bar links. (Fig 1-1)

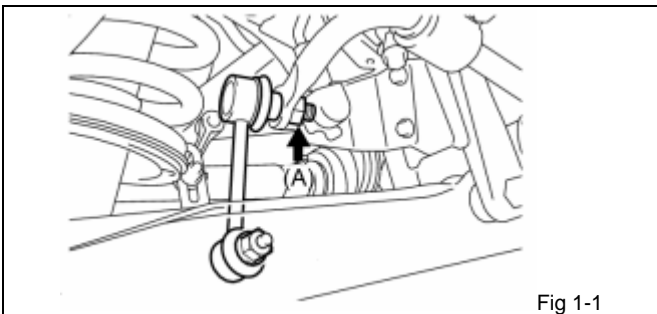

(b) Remove rear sway bar. (Fig 1-2)

- (1) Remove the 4 bolts, 2 stabilizer brackets, and rear stabilizer bar.

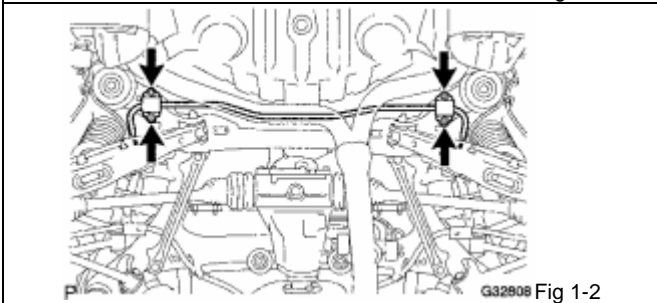

2. Install F-Sport Rear Sway Bar.

(a) Install the supplied bushings onto the new rear sway bar.

- (1) Be sure to install the rear stabilizer bushing so that the cut in the bushing faces the rear of the vehicle. (Fig 2-1)

- (2) Bushings should be positioned to the very edges of the straight portion of the sway bar.

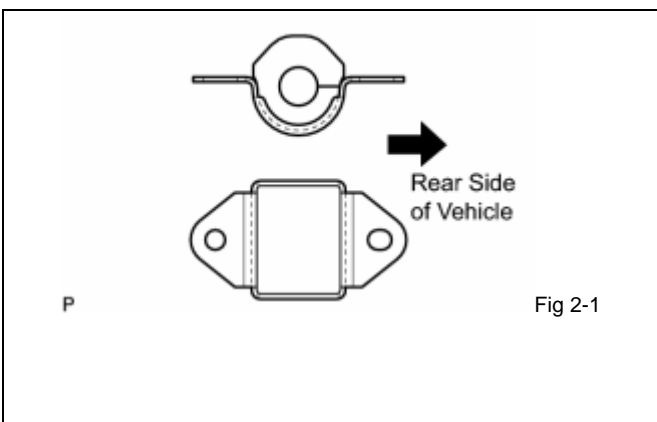

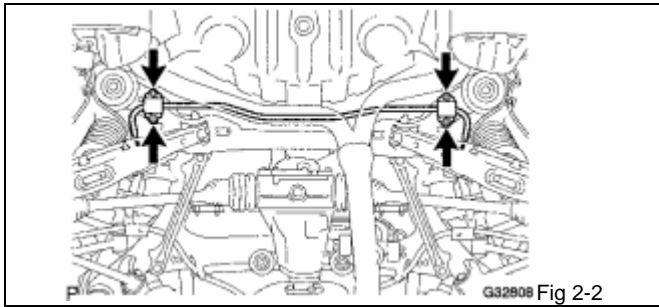

- (b) Install the rear stabilizer bar with the 4 bolts.
(Fig 2-2)

Torque: 32 N·m (326 kgf·cm, 24 ft·lbf)

HINT: Position link ends into the sway bar holes before bolting up the brackets.

- (c) Tighten the sway bar links. (Fig 2-3)

- (1) If the ball joint turns together with the nut, use a hexagon (6 mm) wrench to hold the stud.

Torque: 89 N·m (908 kgf·cm, 66 ft·lbf)

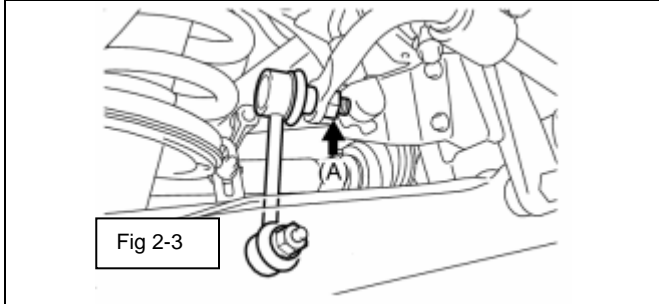

Checklist. These points MUST be checked to ensure a quality installation.

CHECK FOR:

Accessory Function Checks

LOOK FOR:

Vehicle Function Checks

Confirm all suspension components are tightened to specification.