

J106(A)  
Radio Receiver Assembly

J100(A), J101(B), J102(C), J103(D), J104(E), J105(F), J120(G), J118(J)  
Display & Navigation Module Display

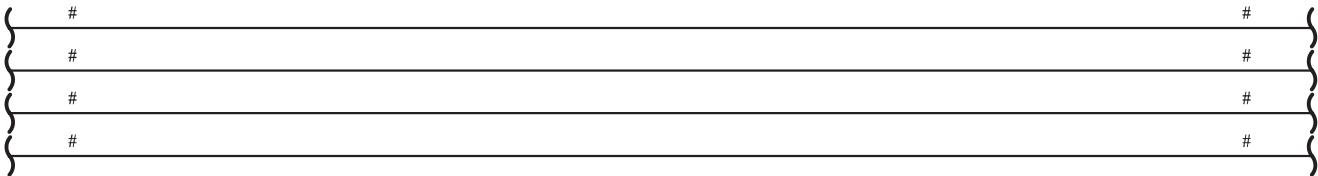

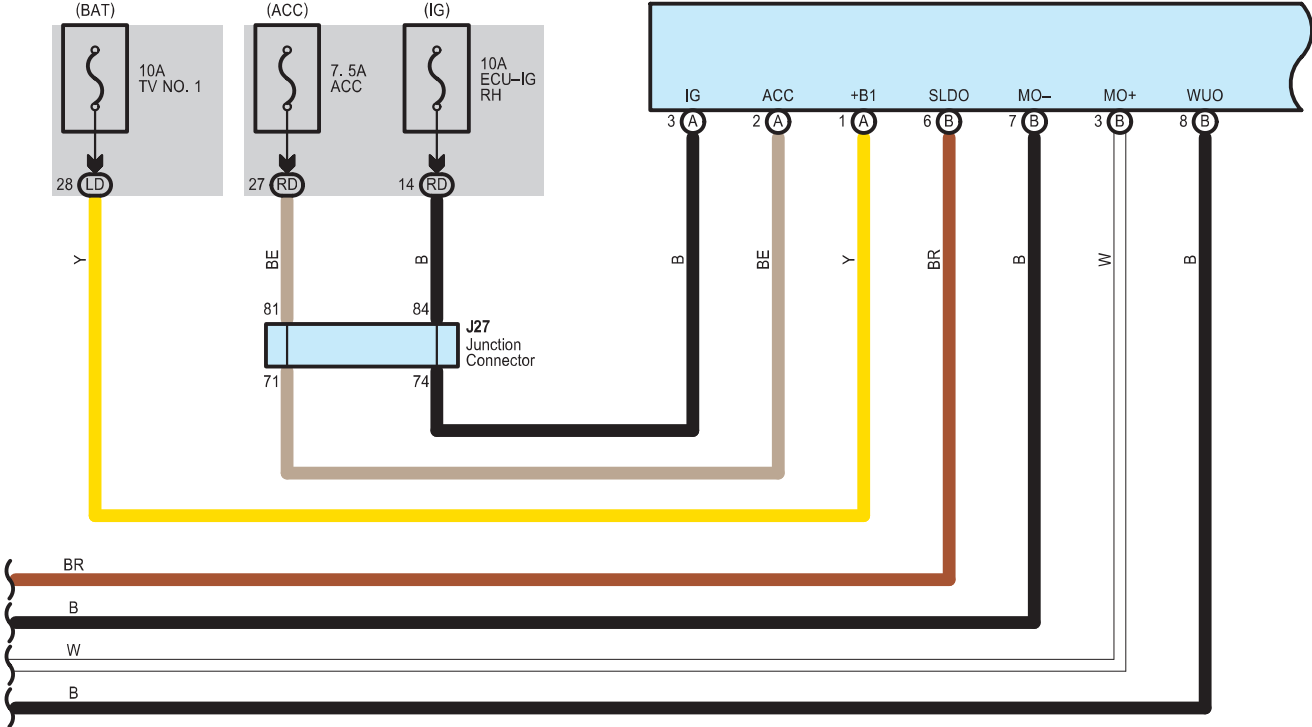
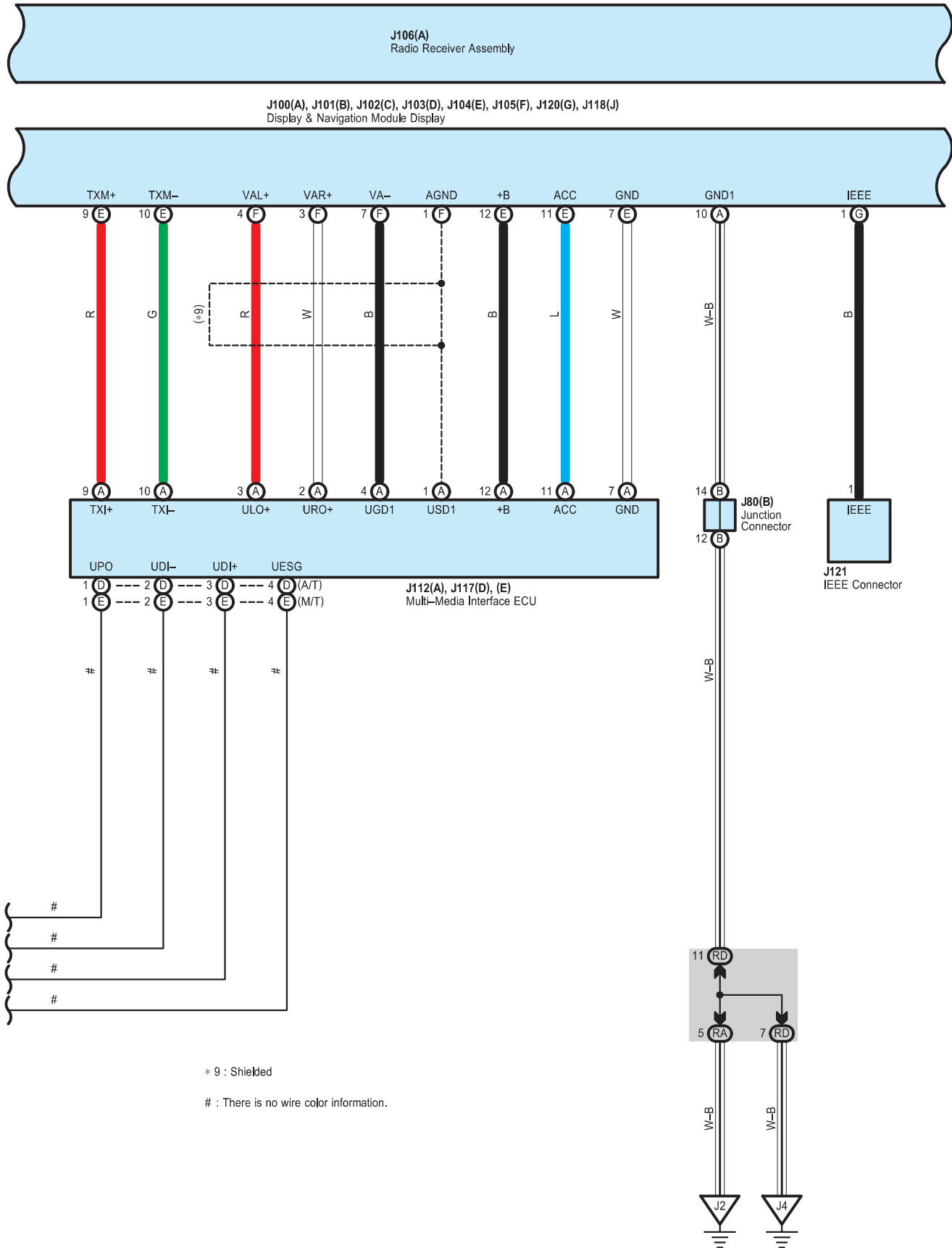

\* 9 : Shielded

# : There is no wire color information.

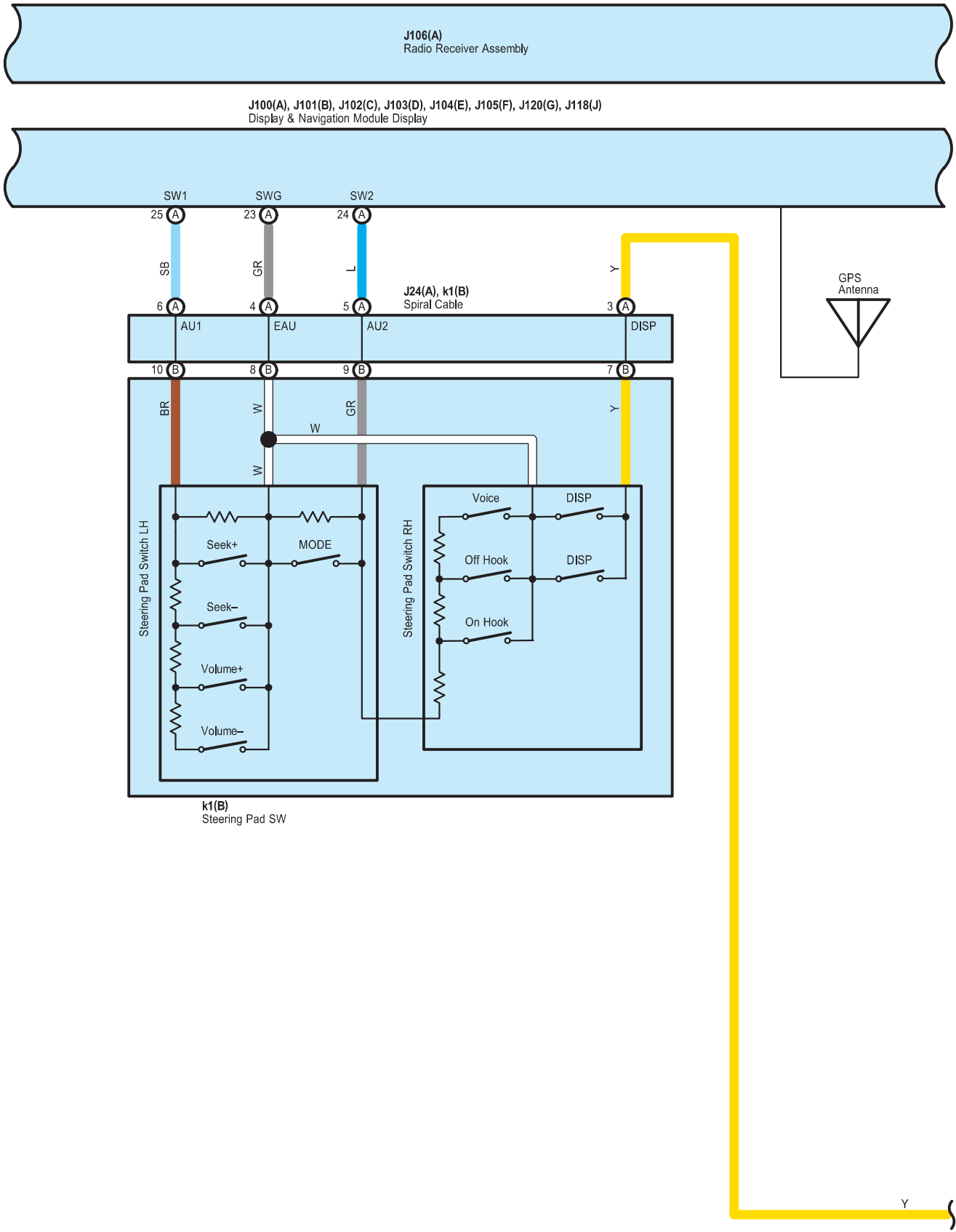

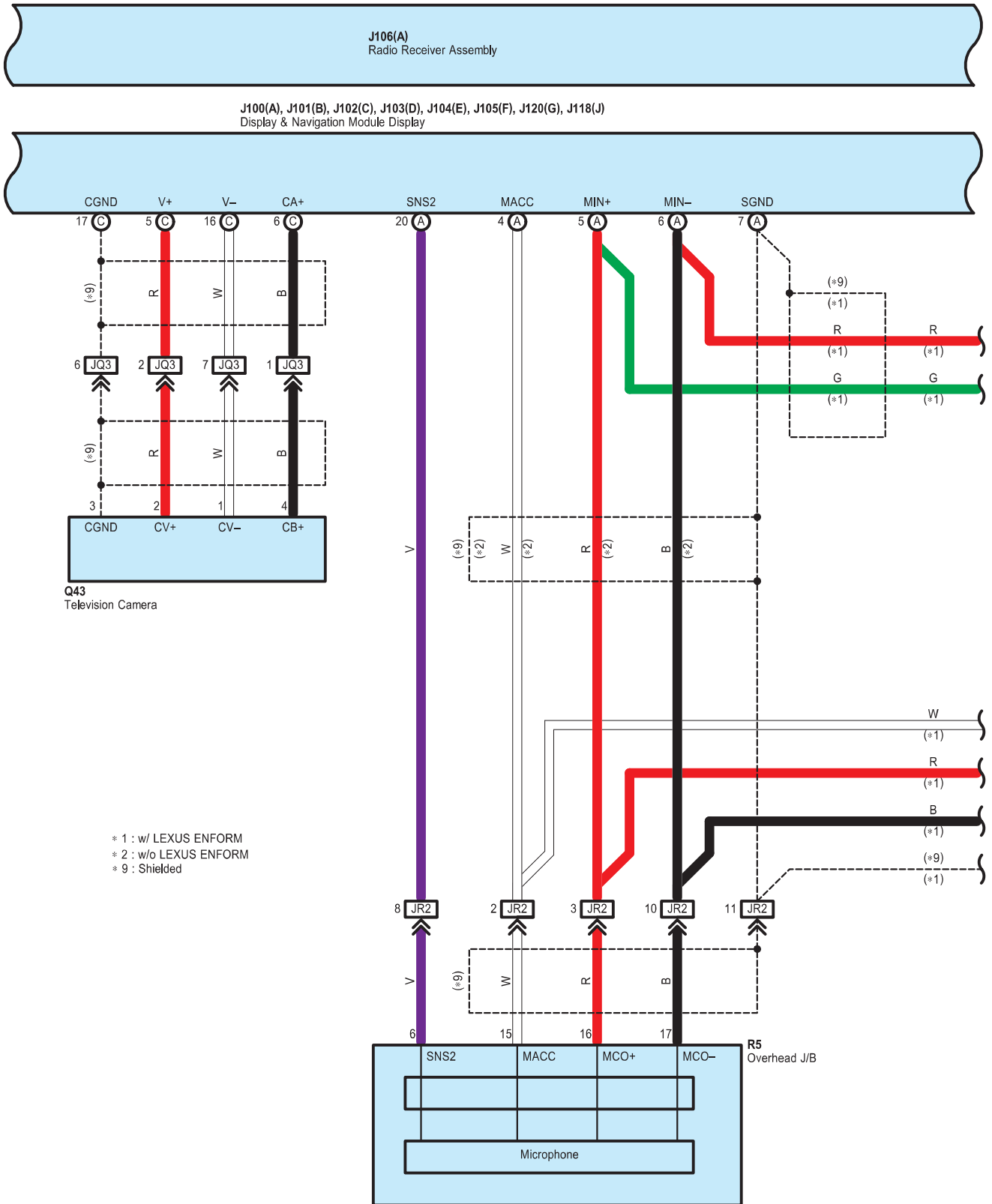

\* 1 : w/ LEXUS ENFORM  
 \* 2 : w/o LEXUS ENFORM  
 \* 9 : Shielded



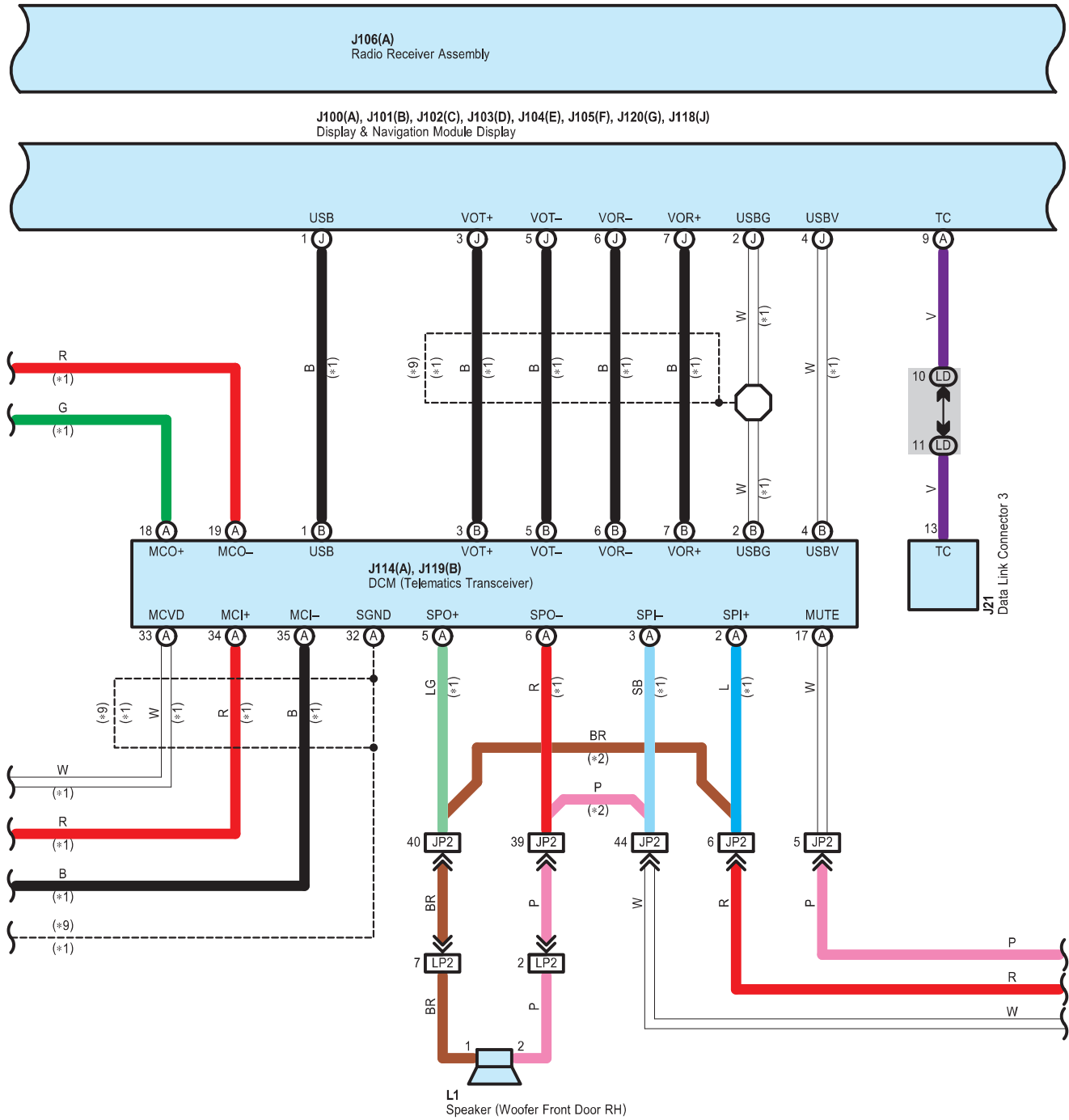

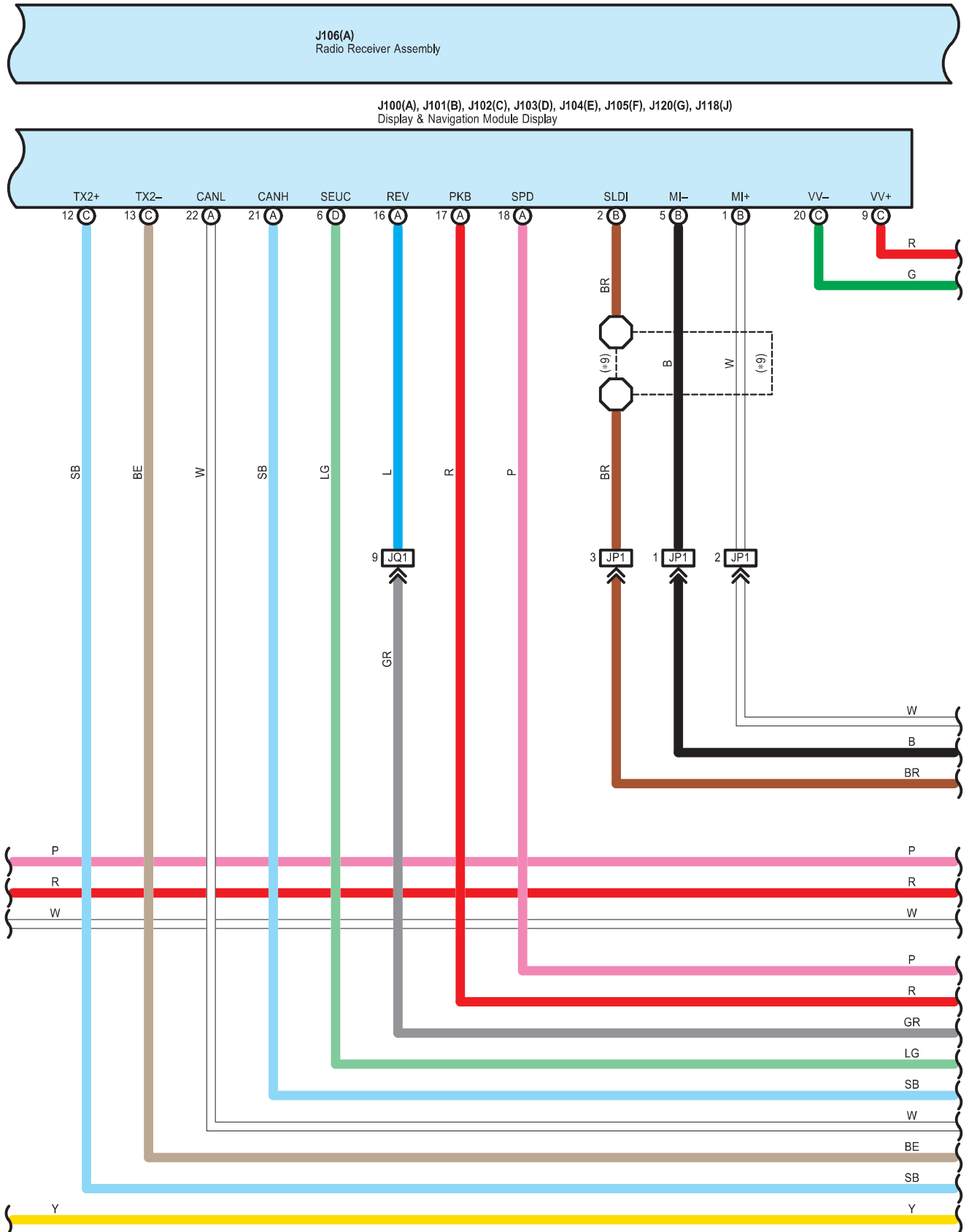



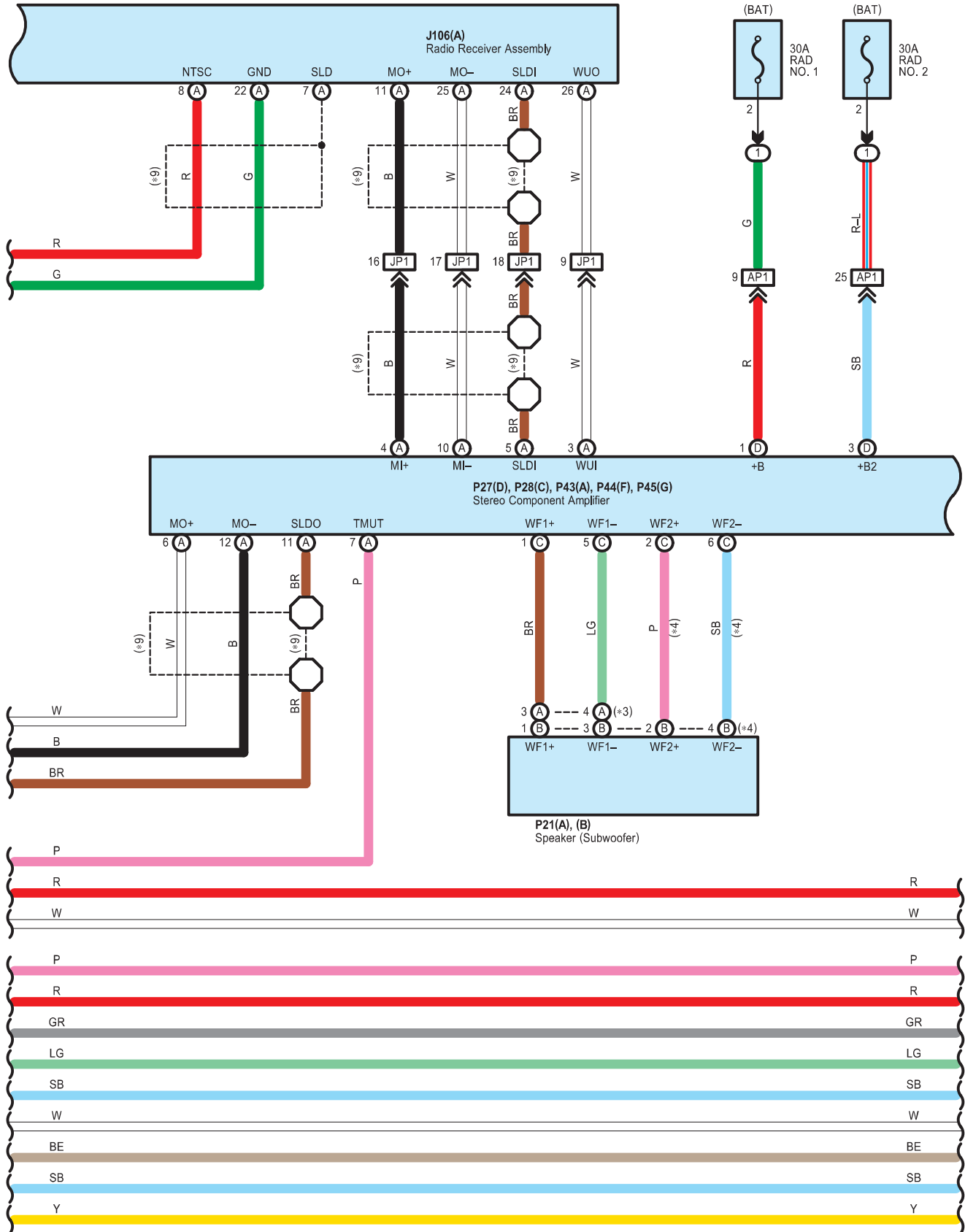

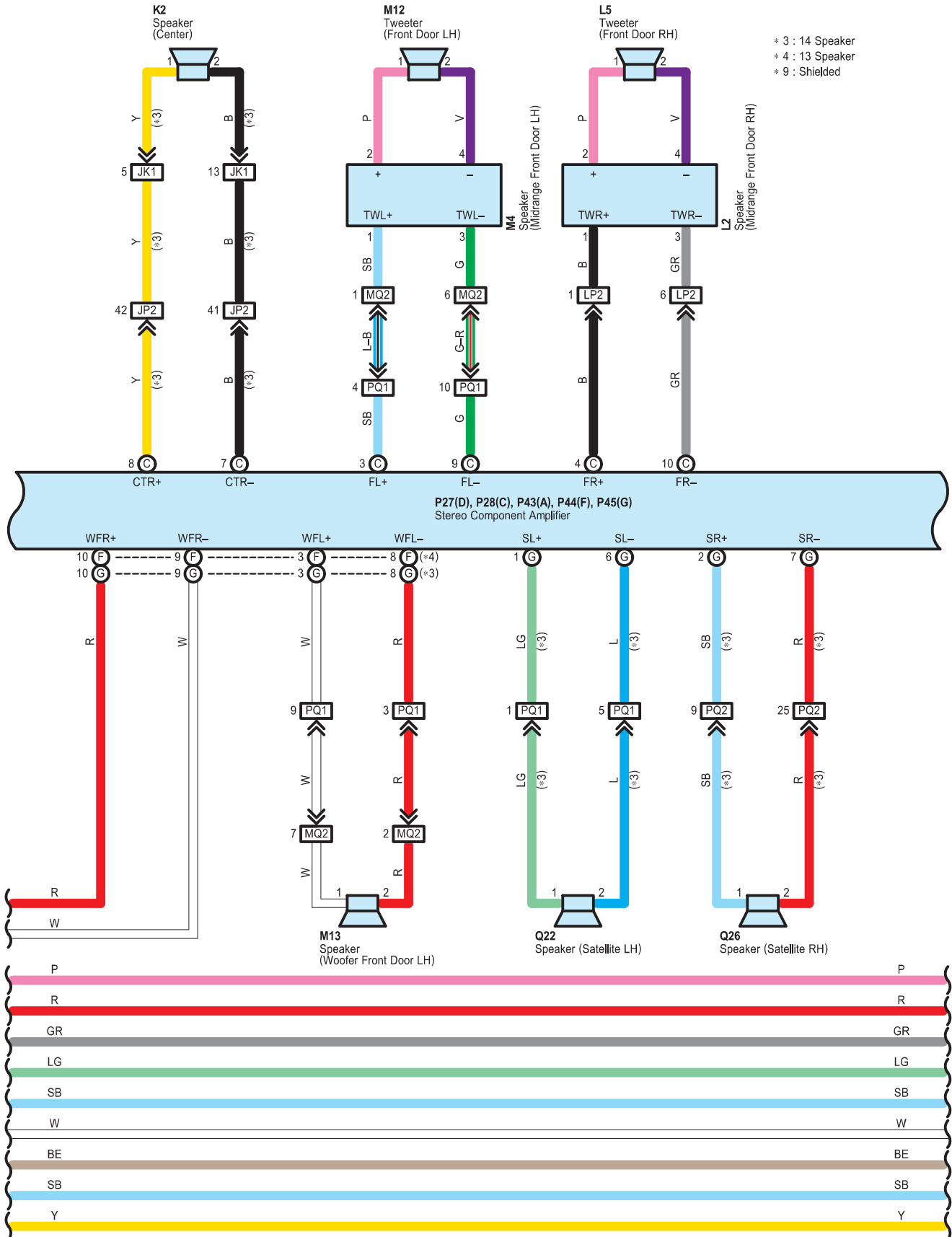

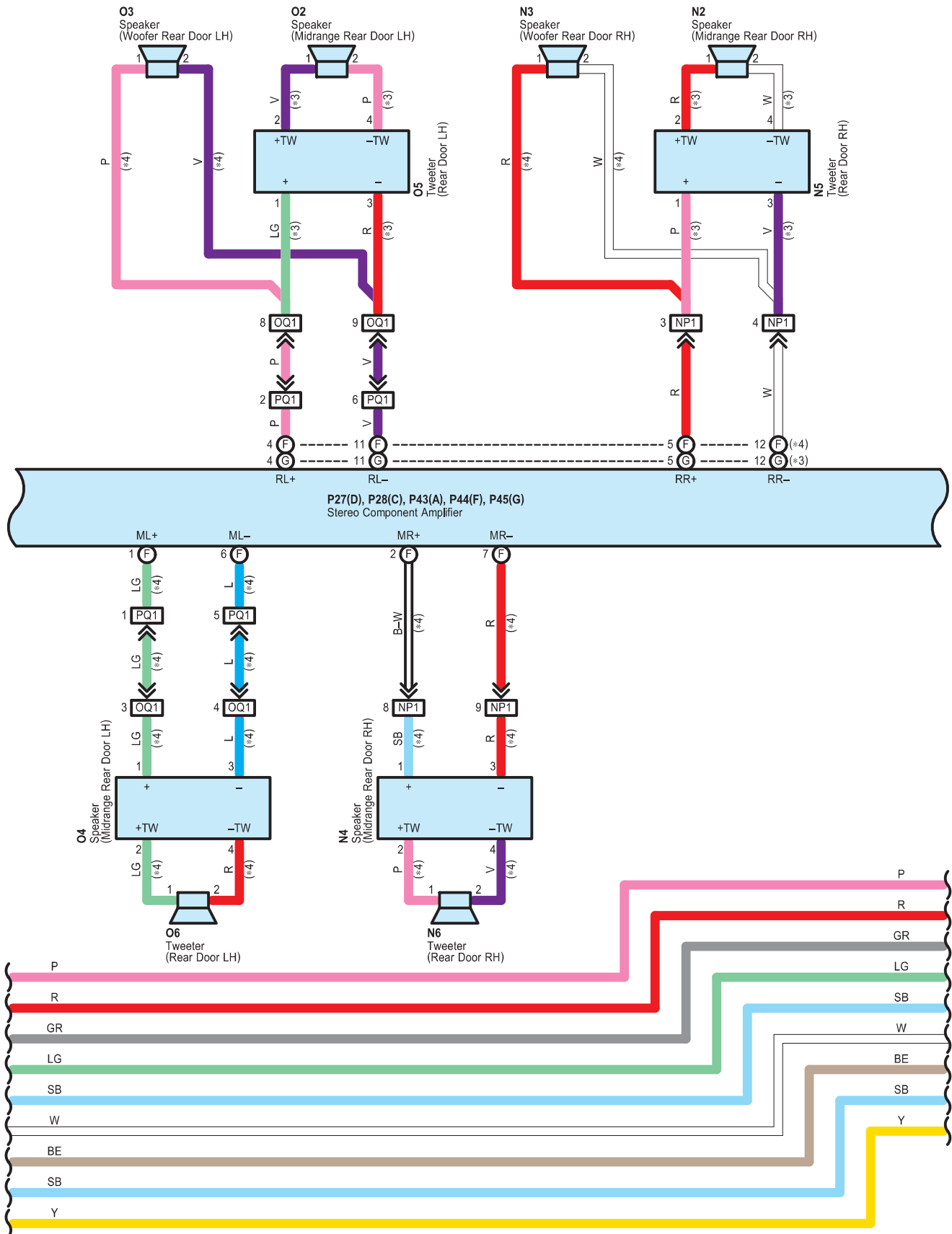



Audio System <w/ LEXUS Navigation System> , LEXUS Navigation System , Parking Assist <Rear View Monitor>

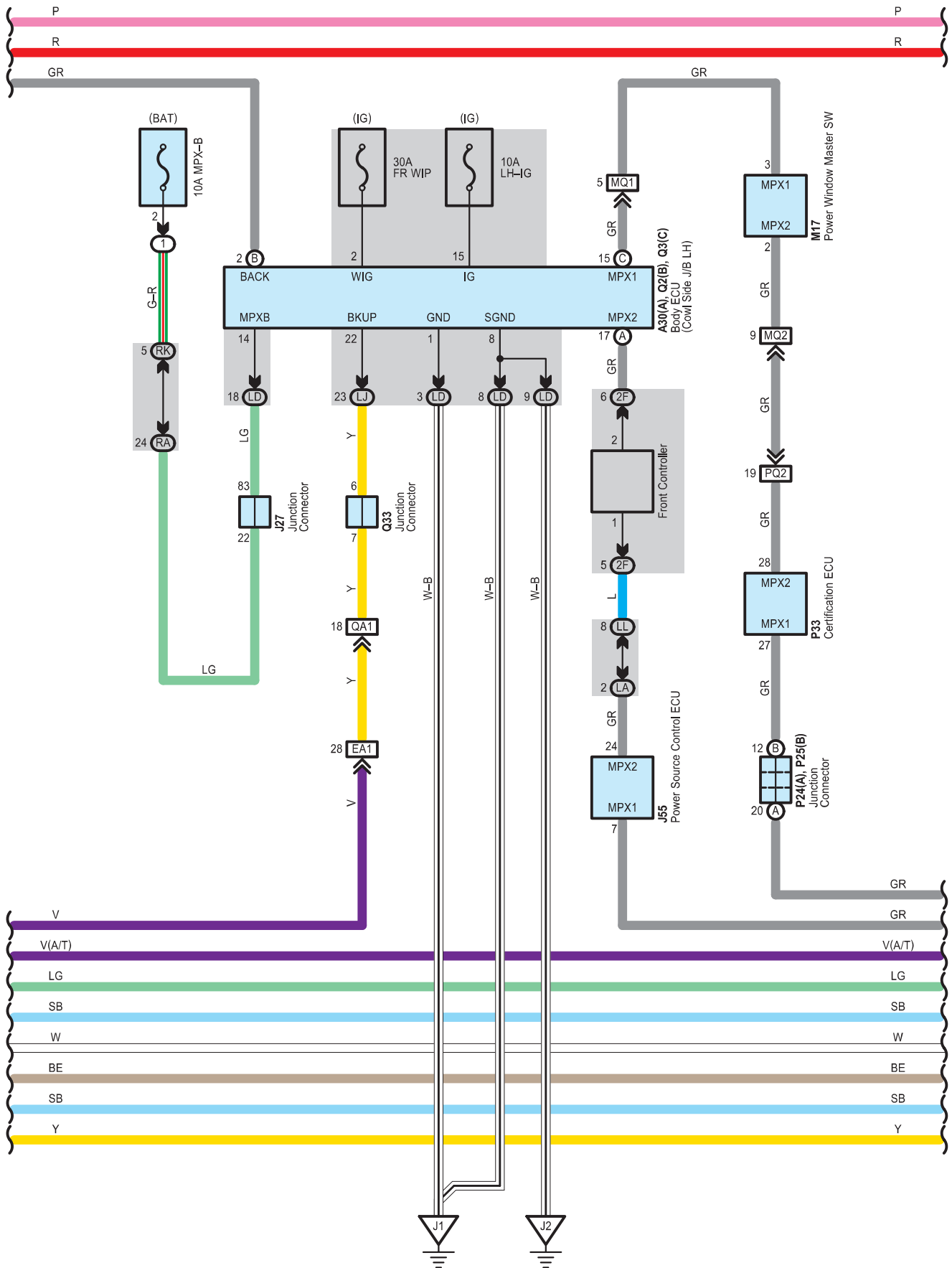

Audio System <w/ LEXUS Navigation System> , LEXUS Navigation System , Parking Assist <Rear View Monitor>

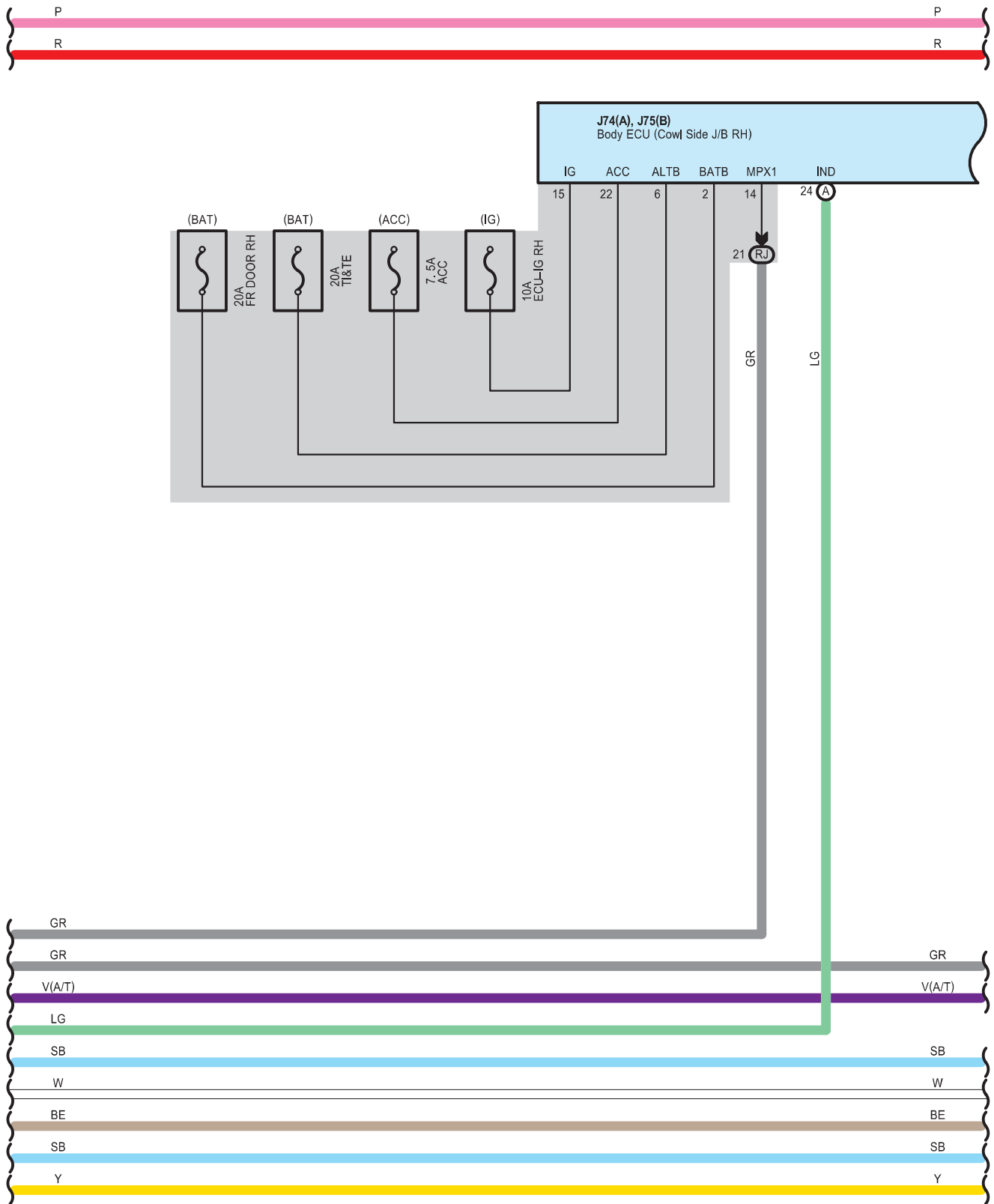

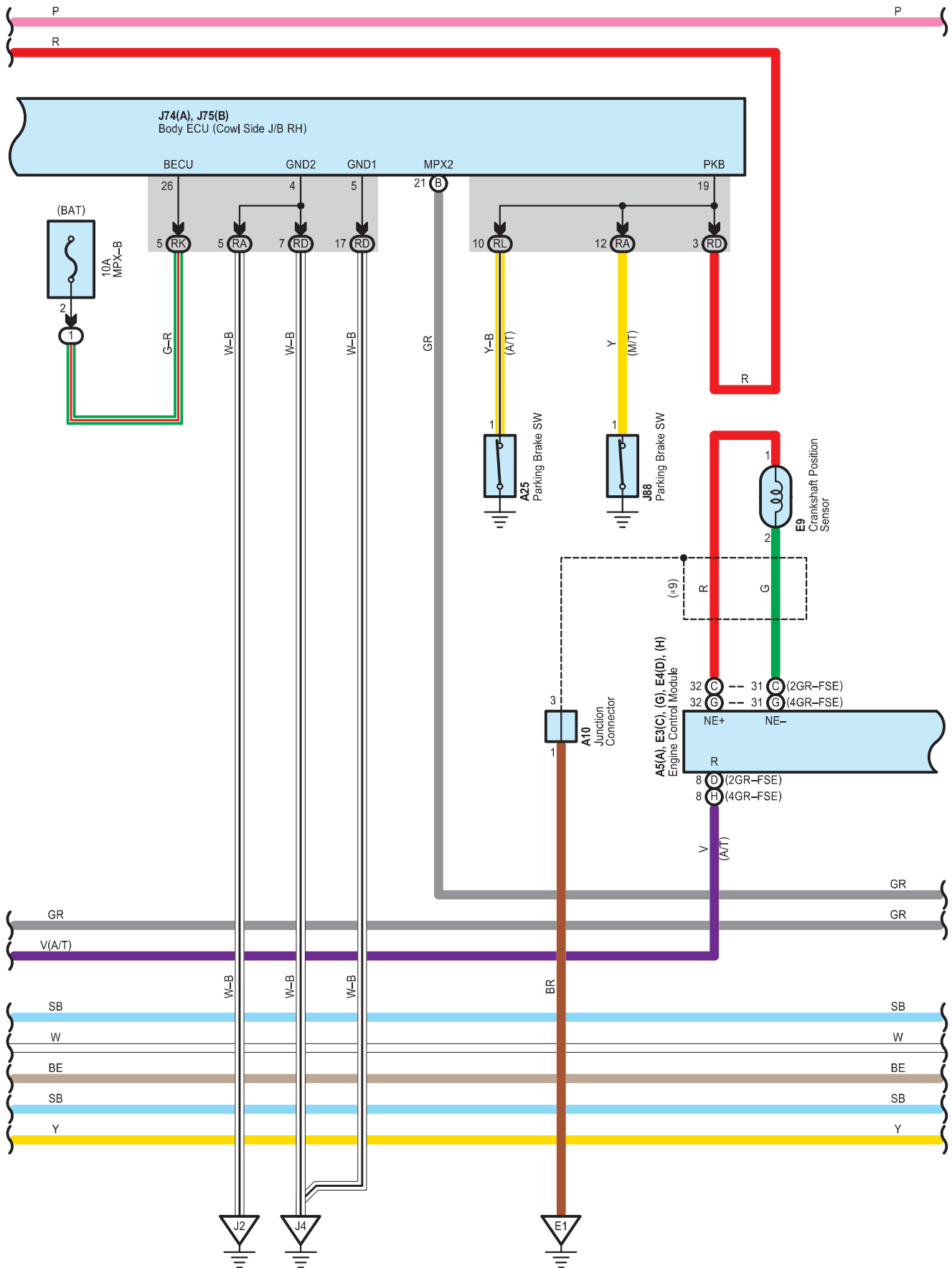

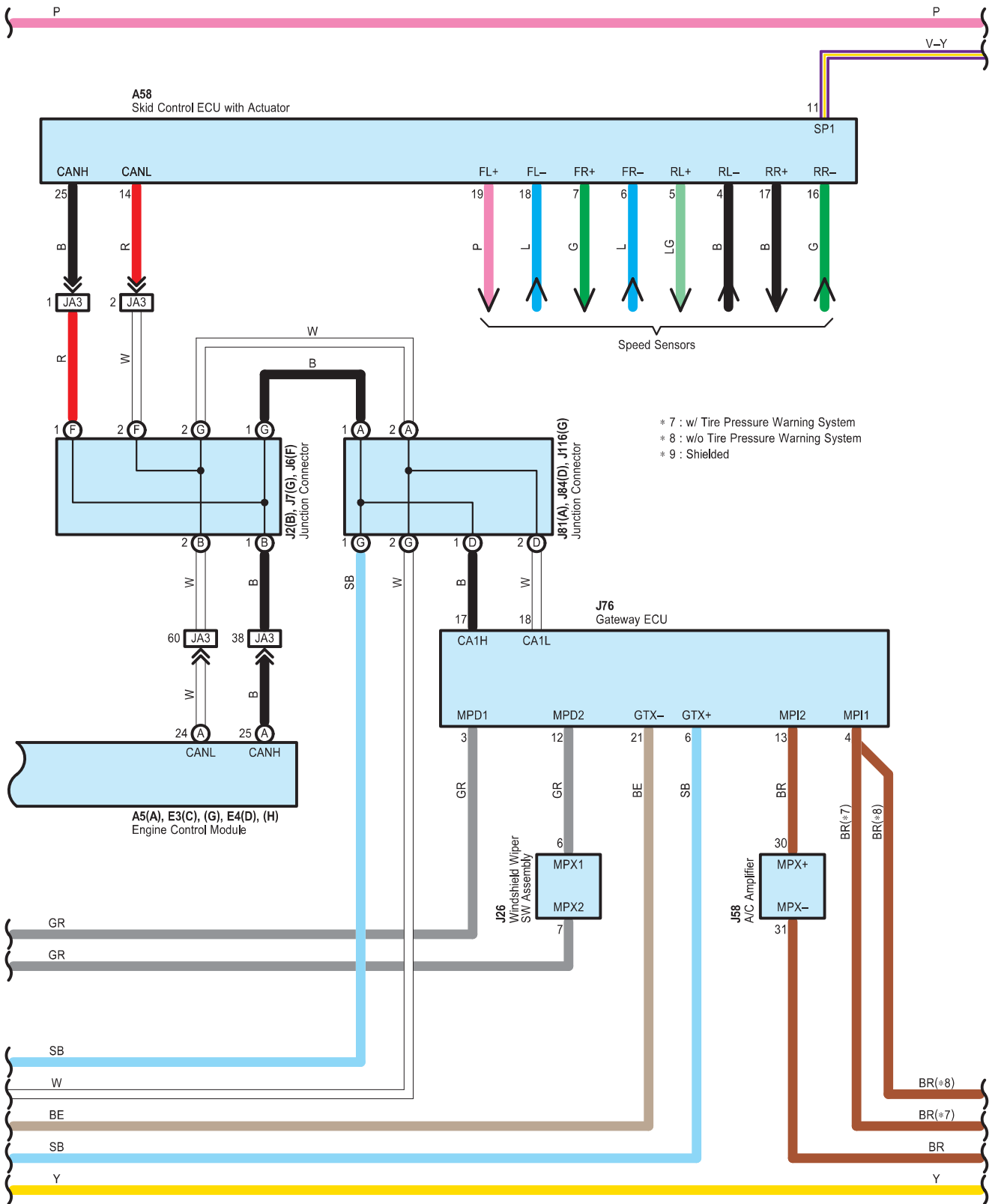



Audio System <w/ LEXUS Navigation System> , LEXUS Navigation System , Parking Assist <Rear View Monitor>

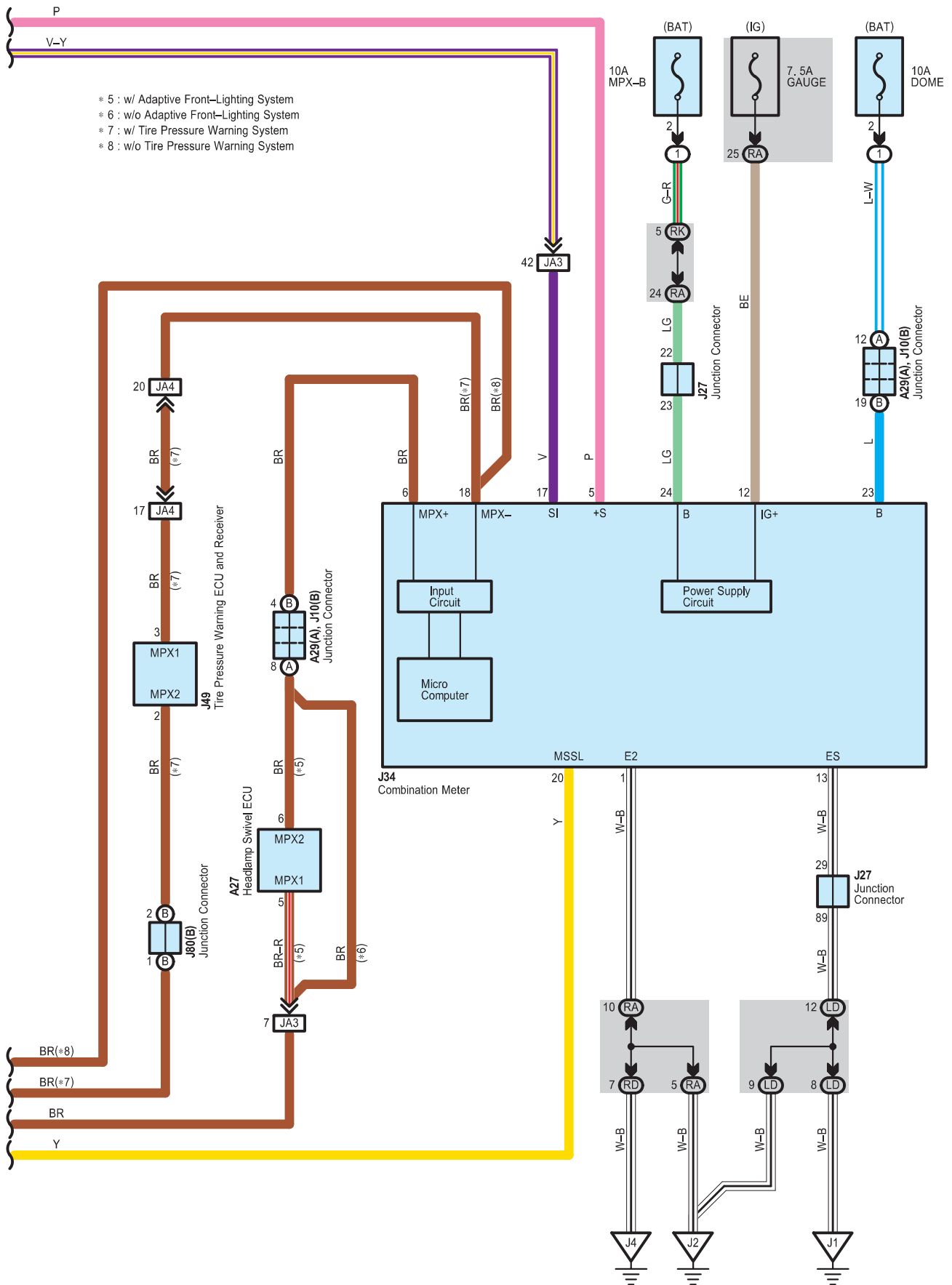

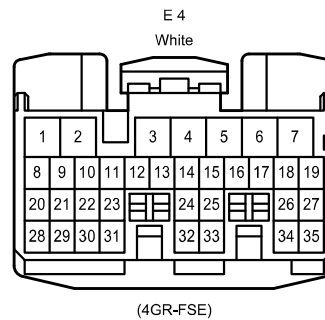
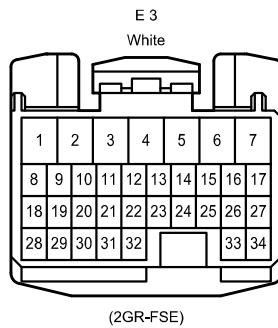
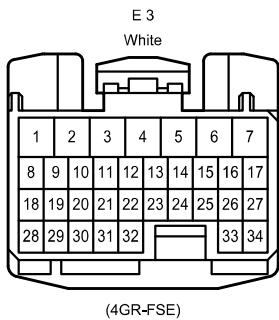
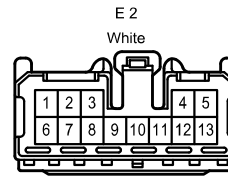
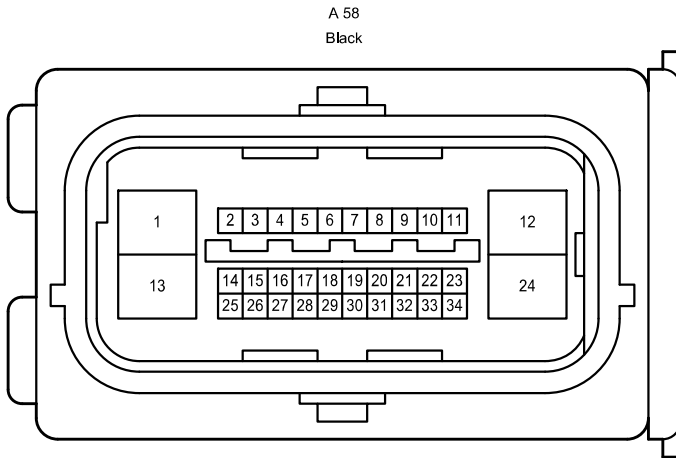
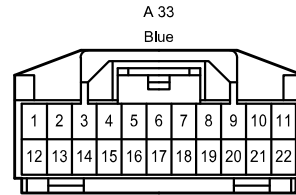
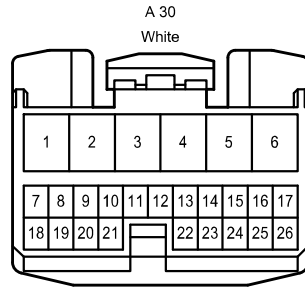
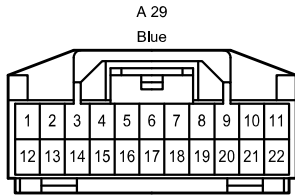
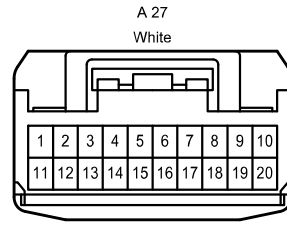
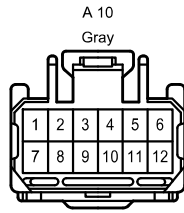
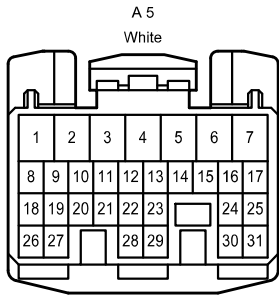

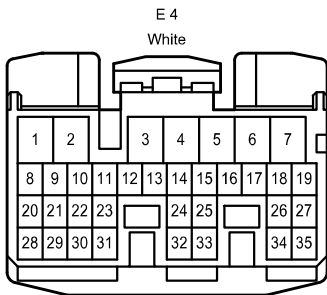

(2GR-FSE)

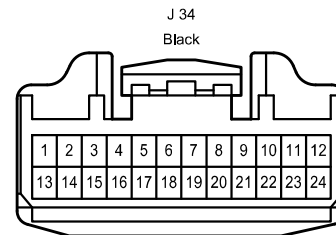
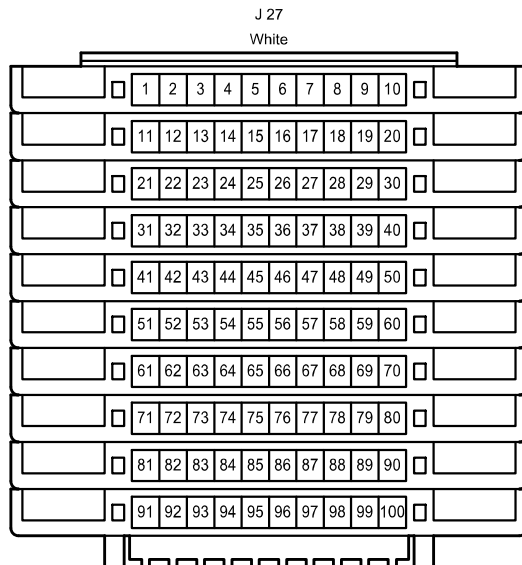
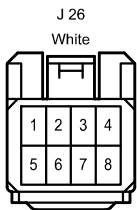
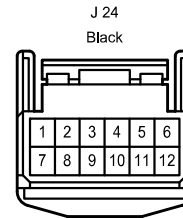
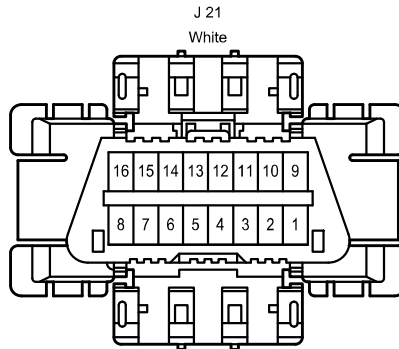
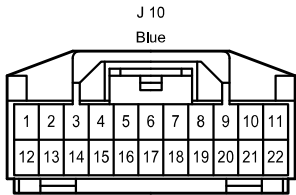
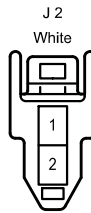
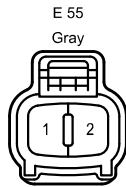
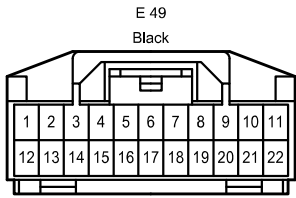
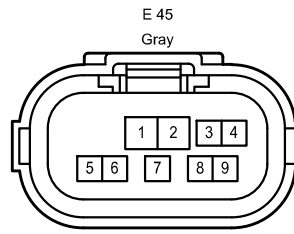
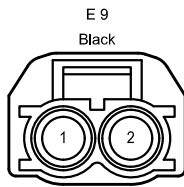

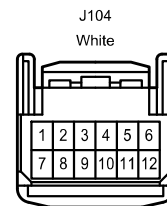
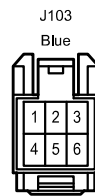
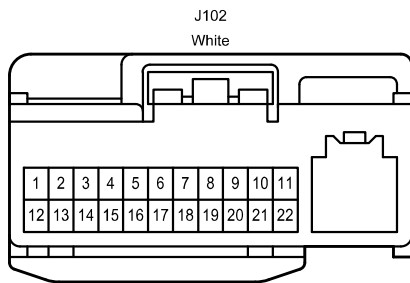
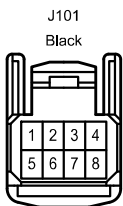
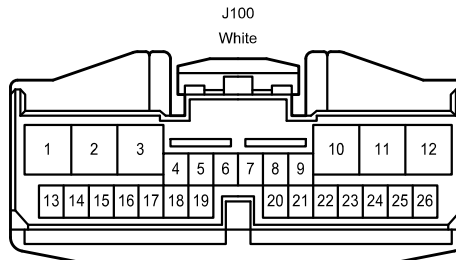
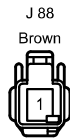
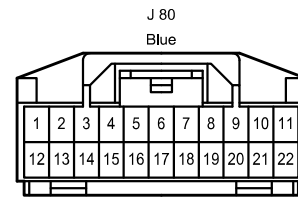
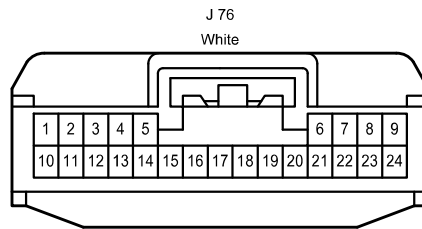
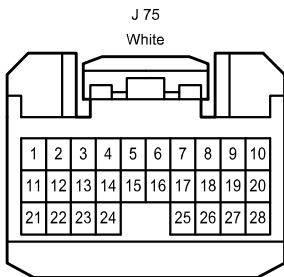
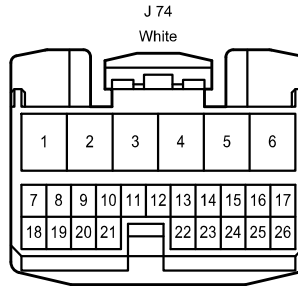
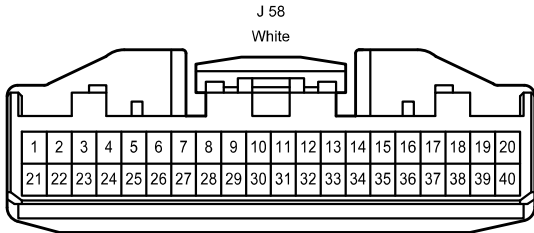
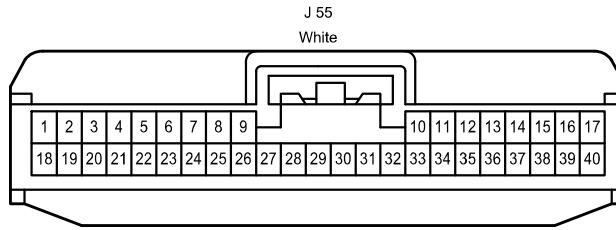
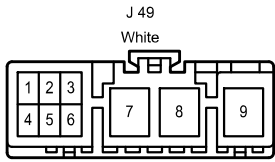

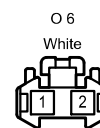
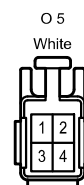
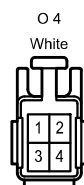
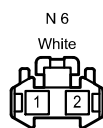
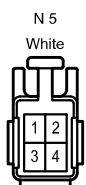
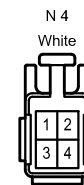
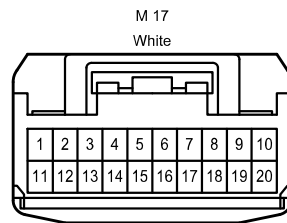
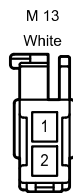
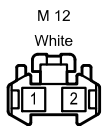
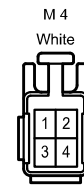
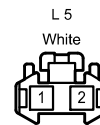
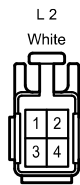
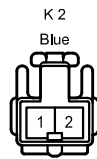
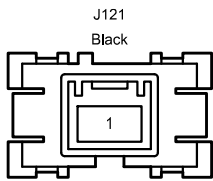
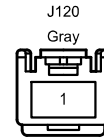
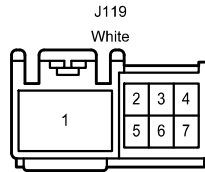
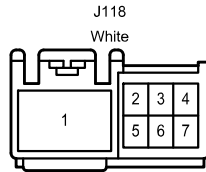
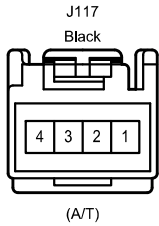
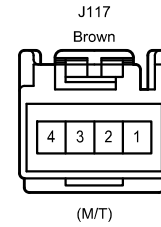
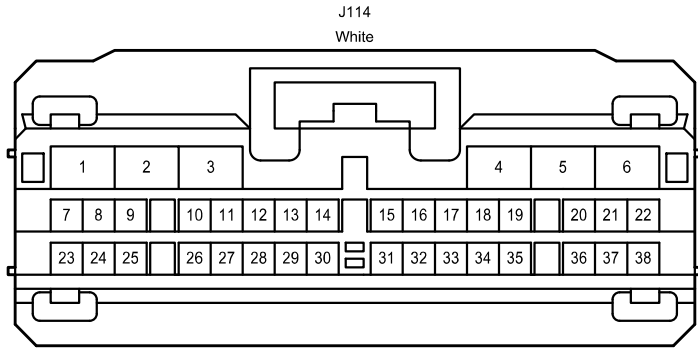
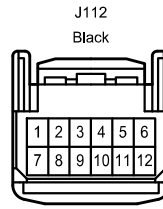
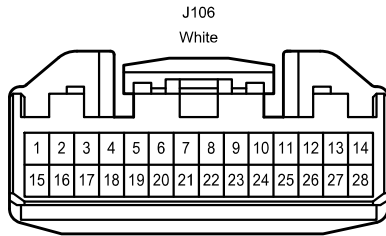
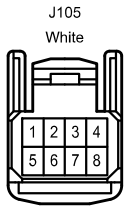

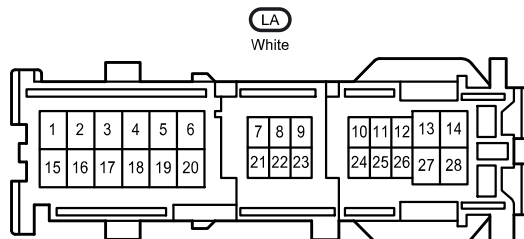
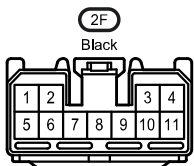
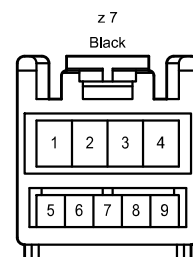
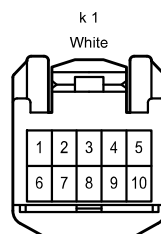
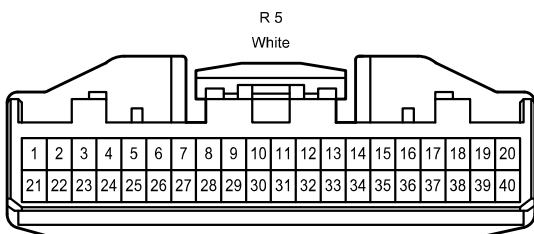
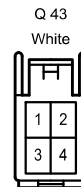
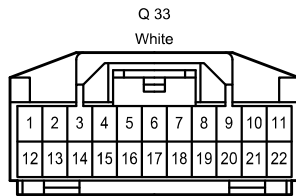
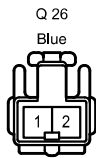
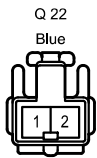
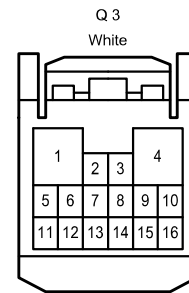
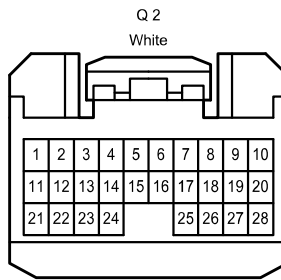
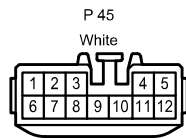
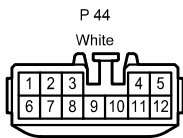
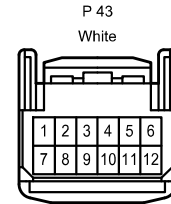
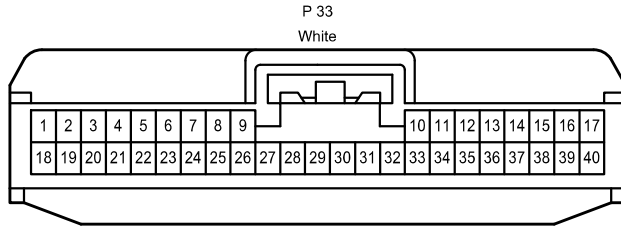
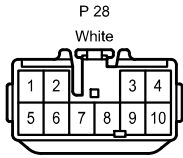
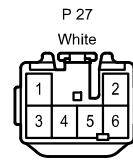
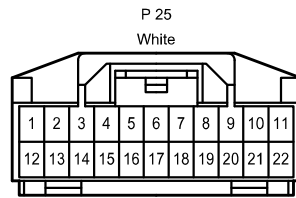
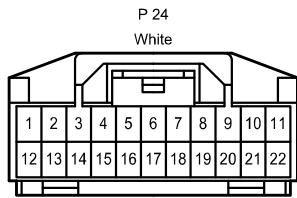
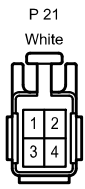

LD  
White

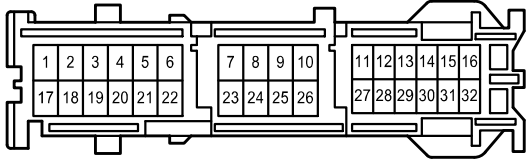

LJ  
Gray

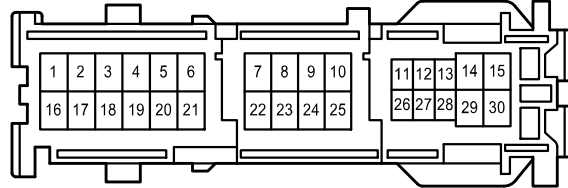

LK  
Gray



LL  
Gray

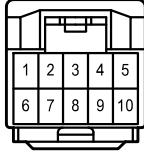

RA  
White

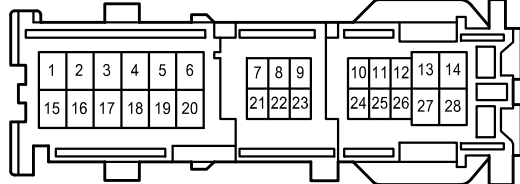

RD  
White

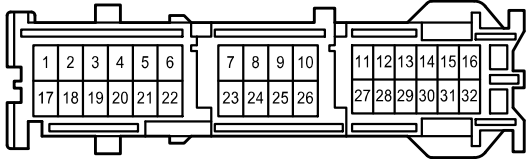

RJ  
Gray

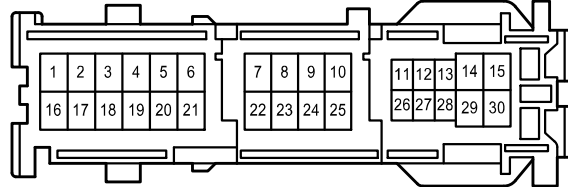

RK  
Gray



RL  
Gray

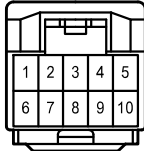

AE1  
White

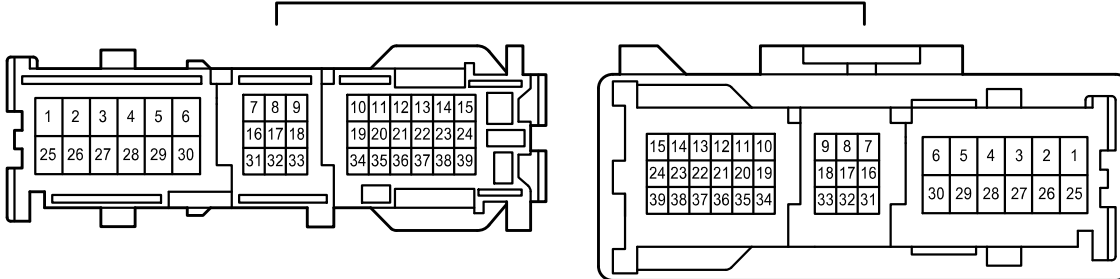

AP1  
White

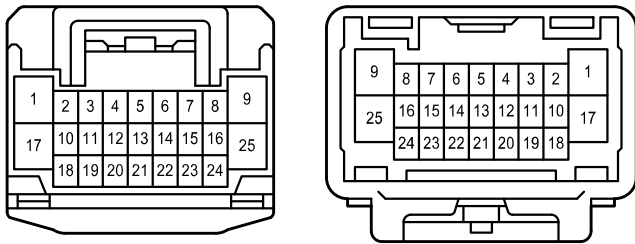

JA3  
White

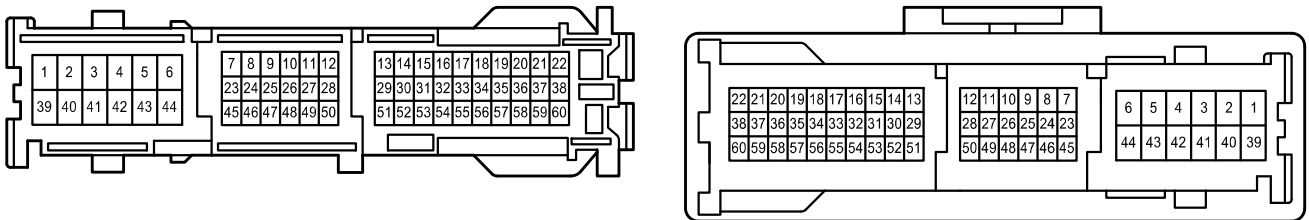

JA4  
White

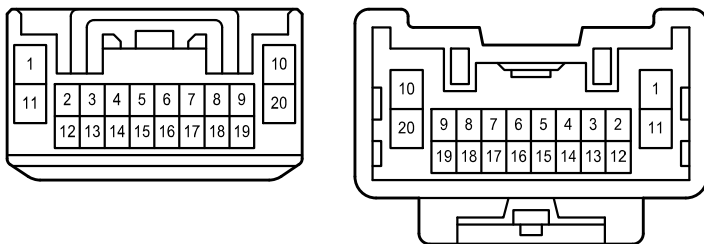

JK1  
White

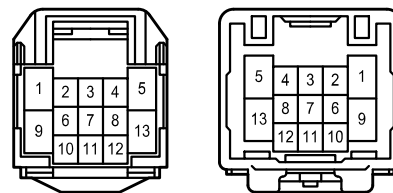

JP1  
White

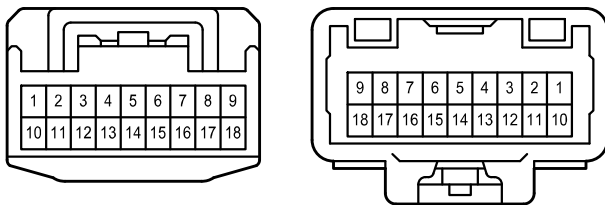

JP2  
White

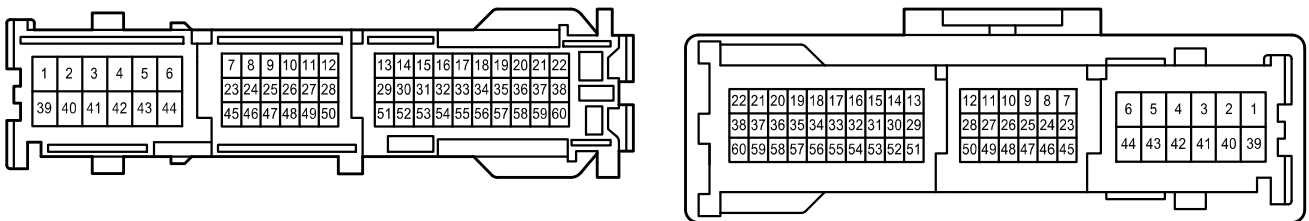



JQ1  
White

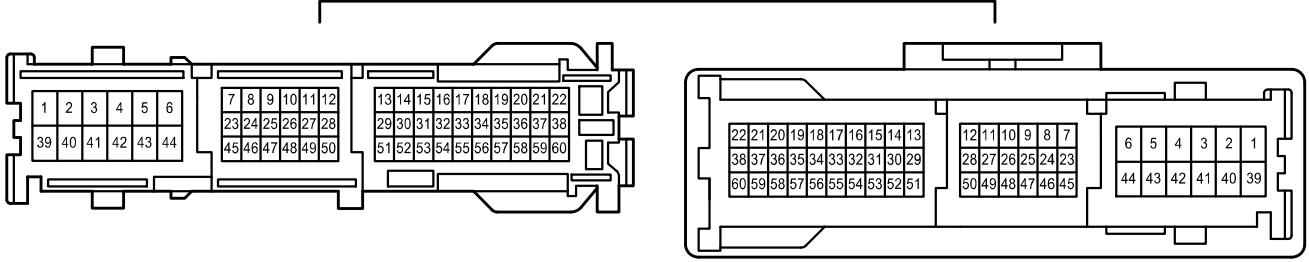

JQ3  
White

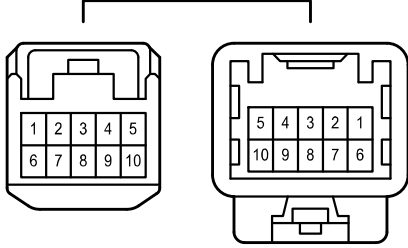

JR2  
White

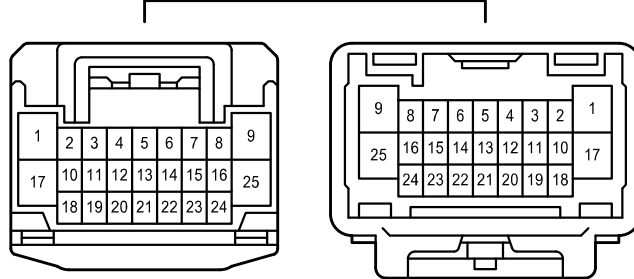

LP2  
White

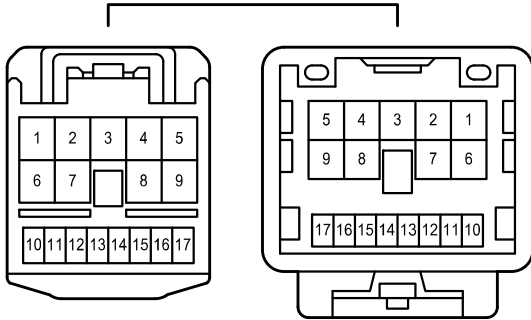

MQ1  
White

