

INSPECTION

1. INSPECT ROTOR

- (a) Check the rotor for open circuit.
Using an ohmmeter, check that there is continuity between the slip rings.

Standard resistance: 2.2 – 2.4 Ω at 20°C (68°F)

If there is no continuity, replace the rotor.

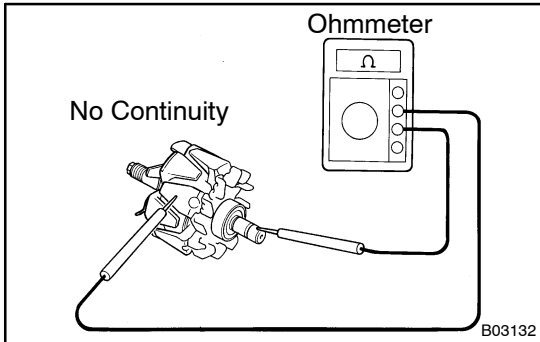

- (b) Check the rotor for ground.
Using an ohmmeter, check that there is no continuity between the slip ring and rotor.

If there is continuity, replace the rotor.

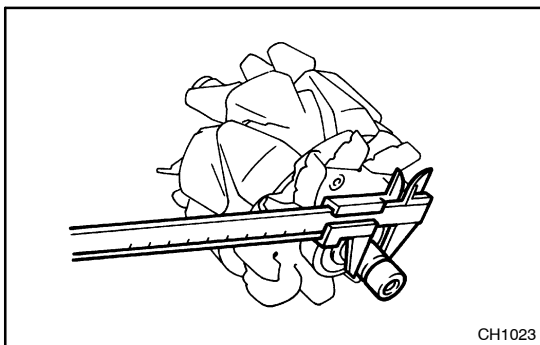

- (c) Check that the slip rings are not rough or scored.
If rough or scored, replace the rotor.

- (d) Using vernier calipers, measure the slip ring diameter.

Standard diameter: 14.2 – 14.4 mm (0.559 – 0.567 in.)

Minimum diameter: 12.8 mm (0.504 in.)

If the diameter is less than minimum, replace the rotor.

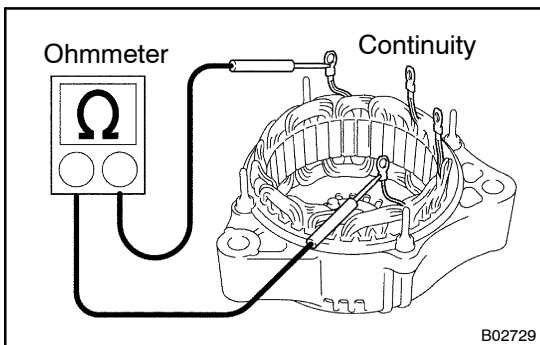

2. INSPECT STATOR (DRIVE END FRAME)

- (a) Check the stator for open circuit.
Using an ohmmeter, check that there is continuity between the coil leads.

If there is no continuity, replace the drive end frame assembly.

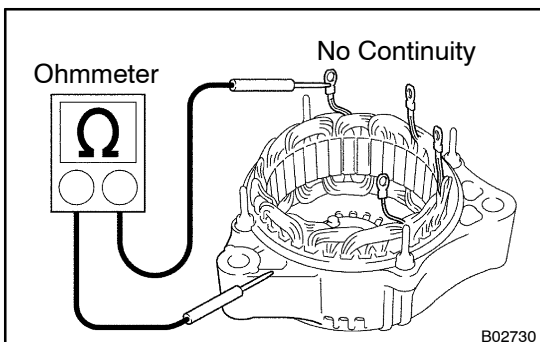

- (b) Check the stator for ground.
Using an ohmmeter, check that there is no continuity between the coil lead and drive end frame.

If there is continuity, replace the drive end frame assembly.

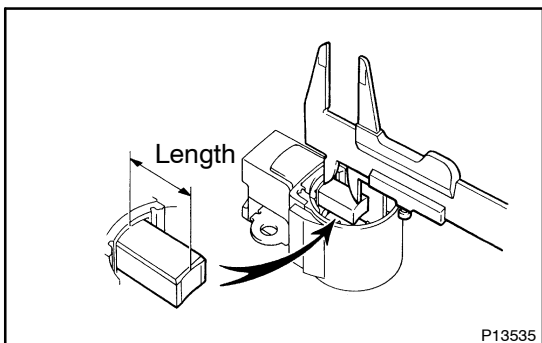

3. INSPECT BRUSHES

Using vernier calipers, measure the exposed brush length.

Standard exposed length:

9.5 – 11.5 mm (0.374 – 0.453 in.)

Minimum exposed length: 1.5 mm (0.059 in.)

If the exposed length is less than minimum, replace the brush holder assembly.

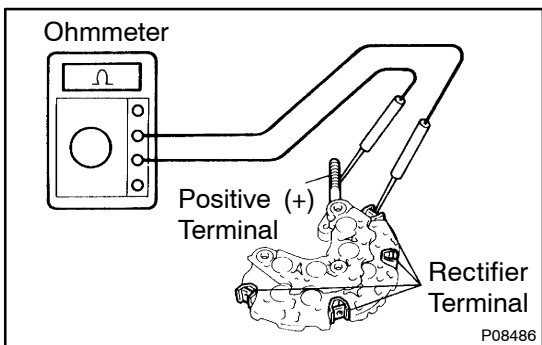

4. INSPECT RECTIFIERS (RECTIFIER HOLDER)

(a) Check the positive (+) rectifier.

- (1) Using an ohmmeter, connect one tester probe to the positive (+) terminal and the other to each rectifier terminal.
- (2) Reverse the polarity of the tester probes and repeat step (a).
- (3) Check that one shows continuity and the other shows no continuity.

If continuity is not as specified, replace the rectifier holder.

(b) Check the negative (-) rectifier.

- (1) Using an ohmmeter, connect one tester probe to each negative (-) terminal and the other to each rectifier terminal.
- (2) Reverse the polarity of the tester probes and repeat step (a).
- (3) Check that one shows continuity and the other shows no continuity.

If continuity is not as specified, replace the rectifier holder.

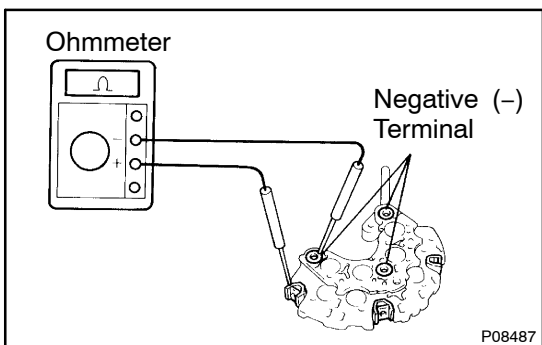

5. INSPECT BEARINGS

Check the bearing is not rough or worn.

If necessary, replace the bearing. (See page CH-12)