

Engine Control

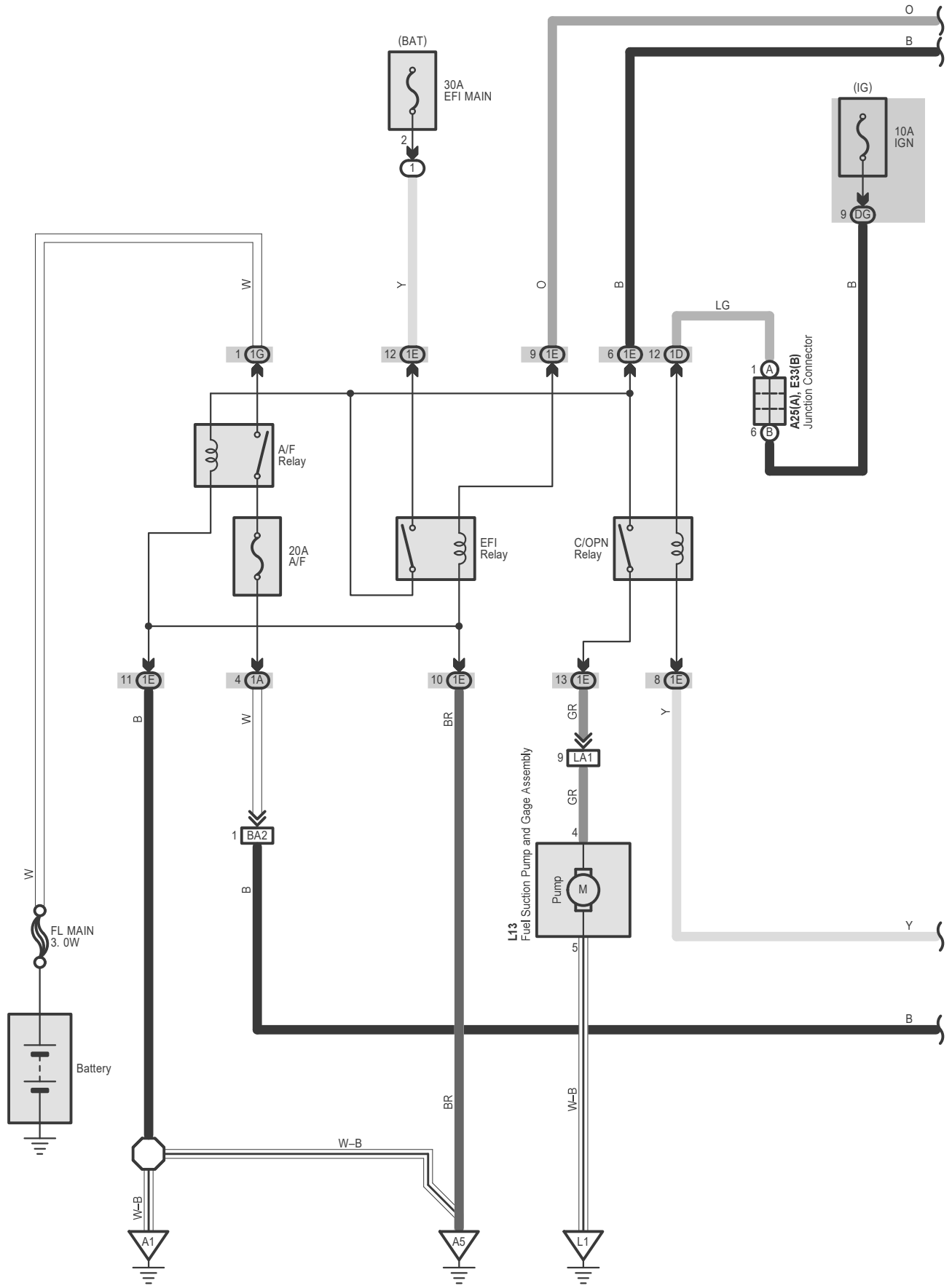

# Engine Control

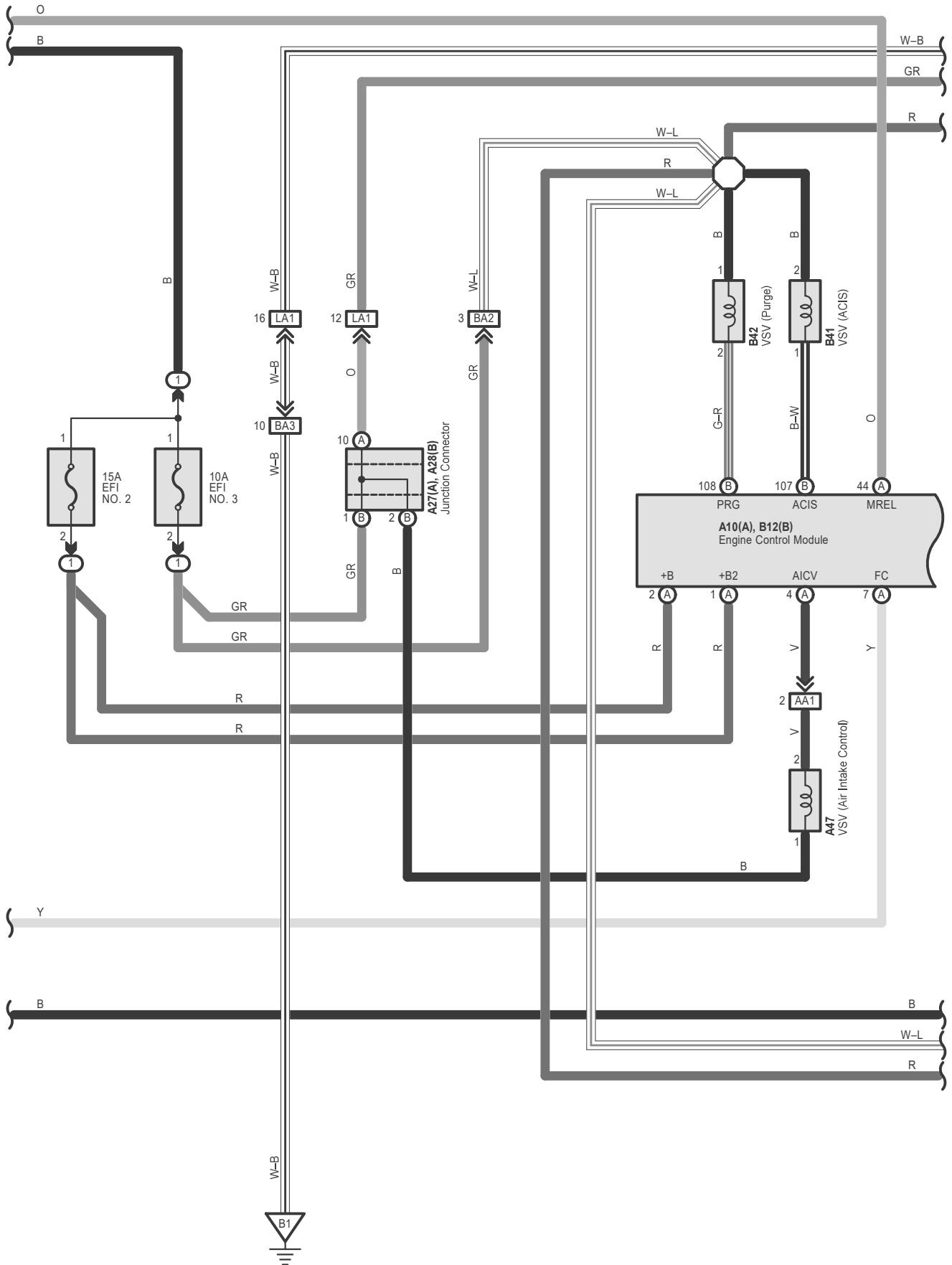

Engine Control

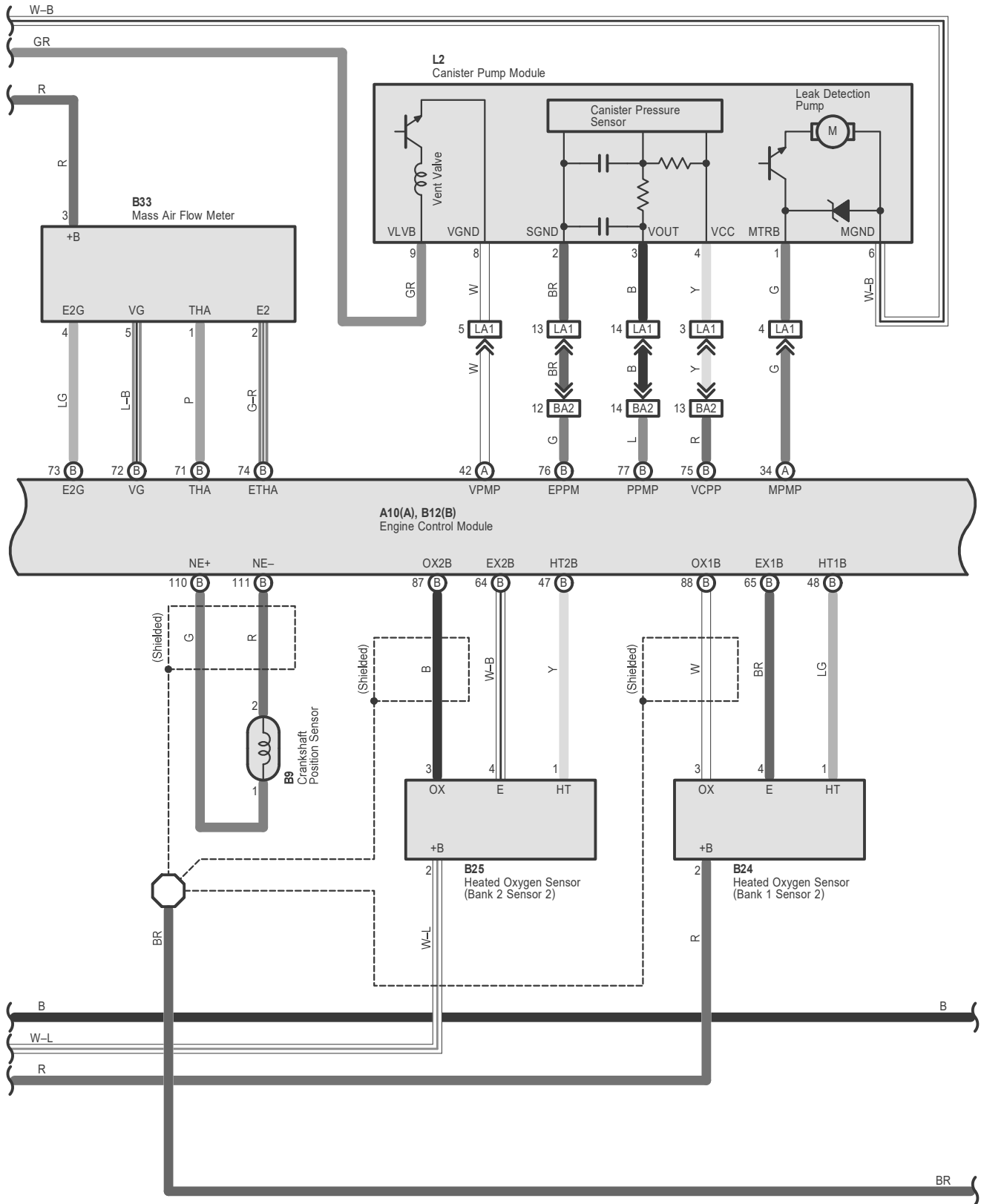

# Engine Control

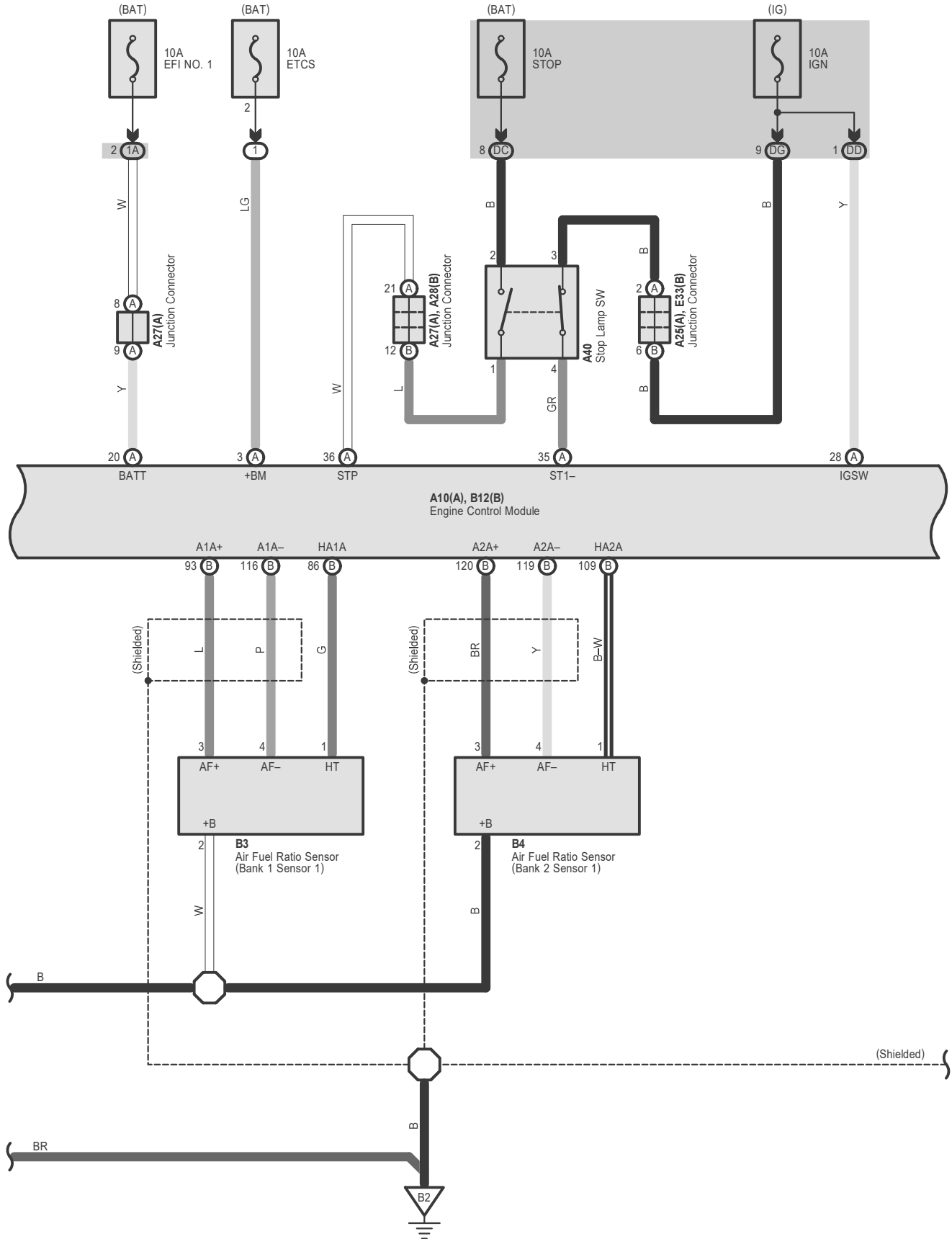

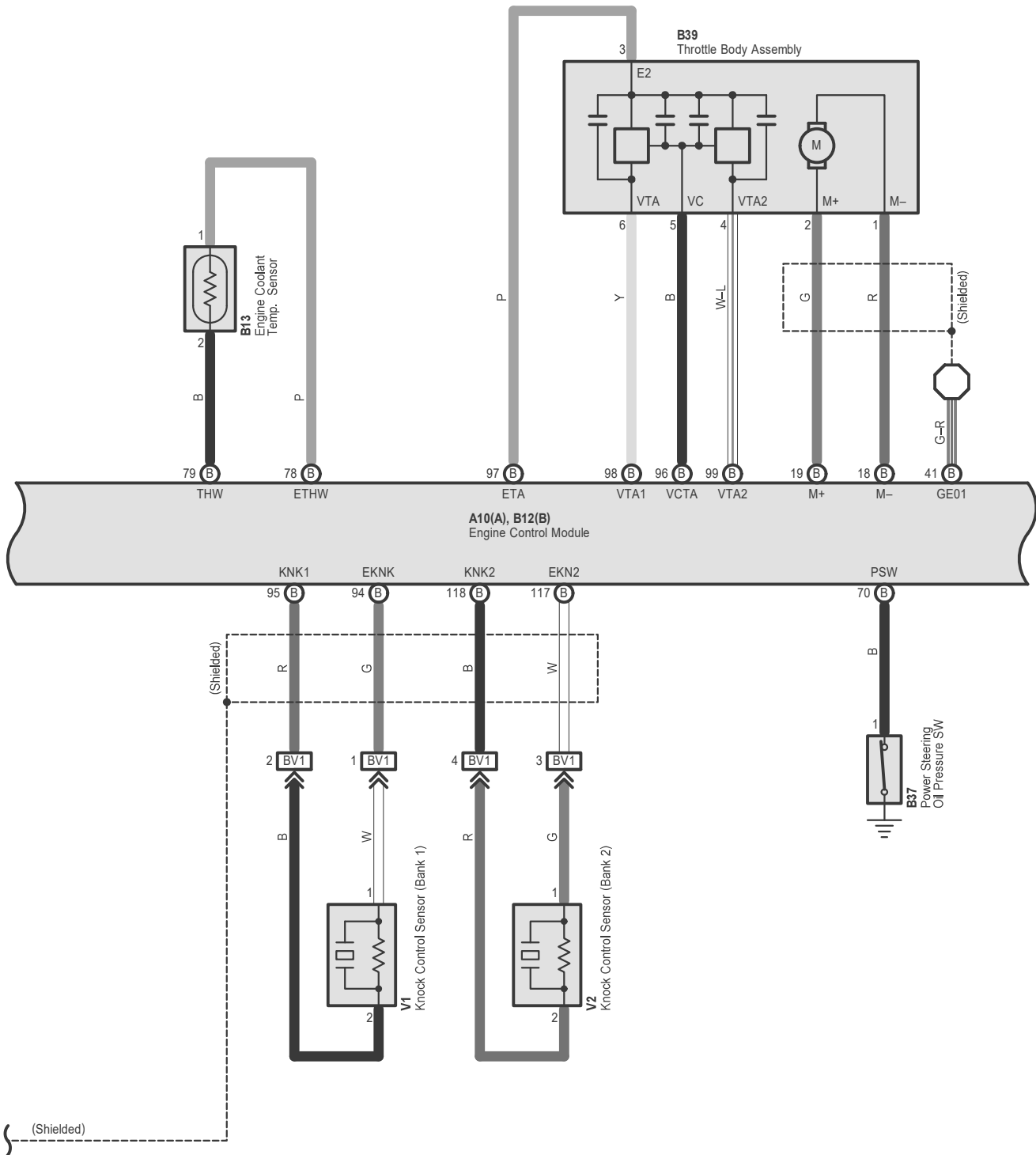

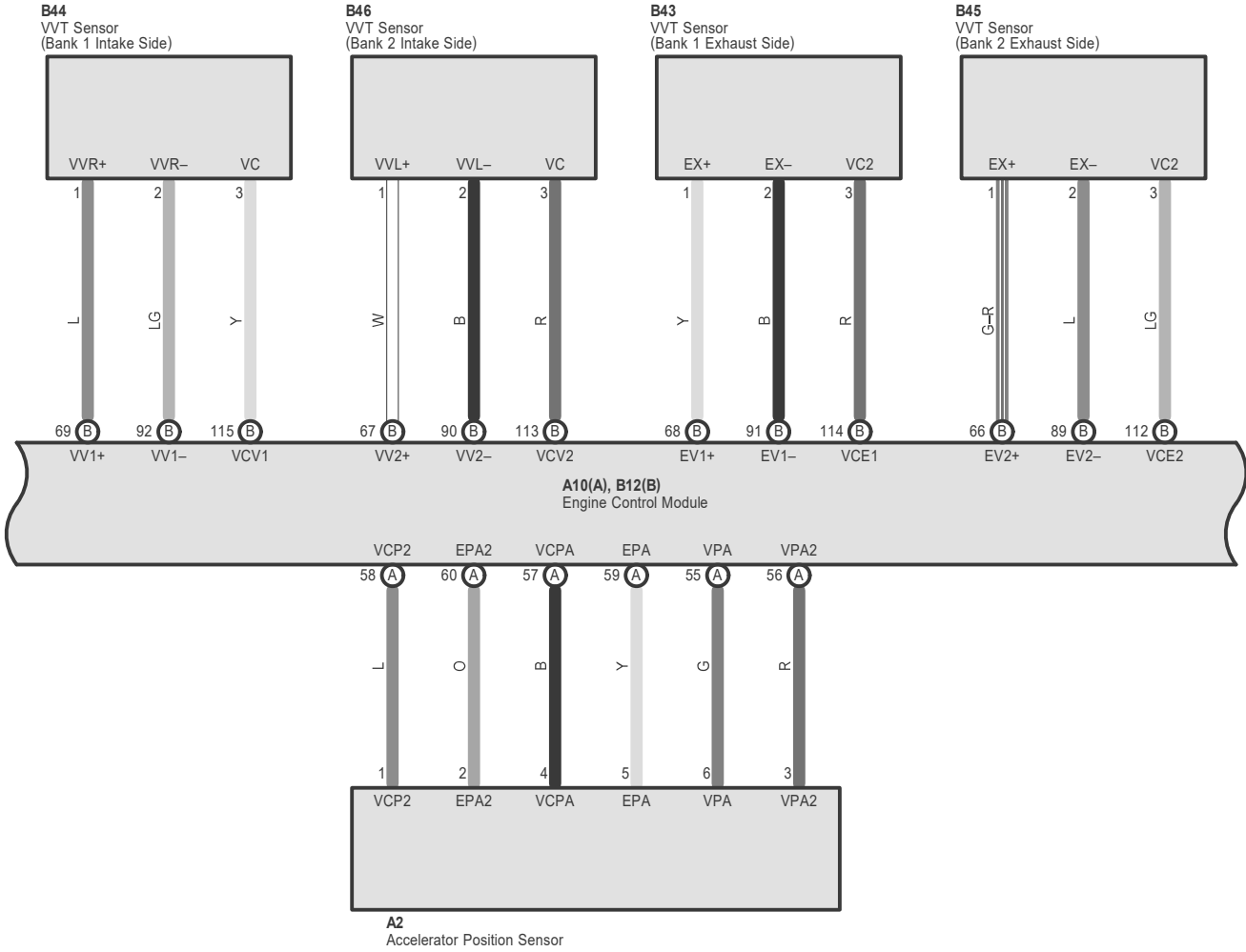

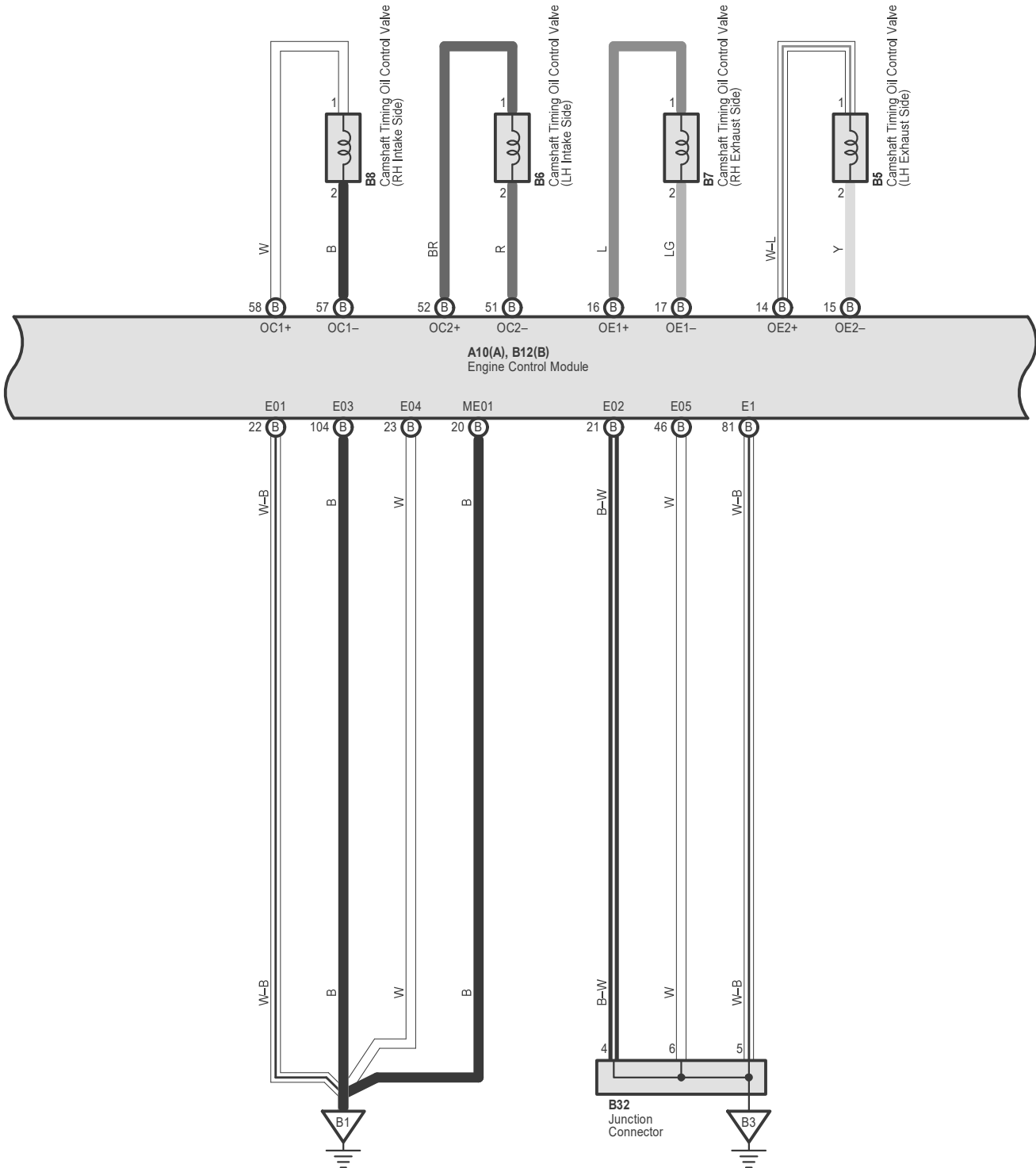

# Engine Control

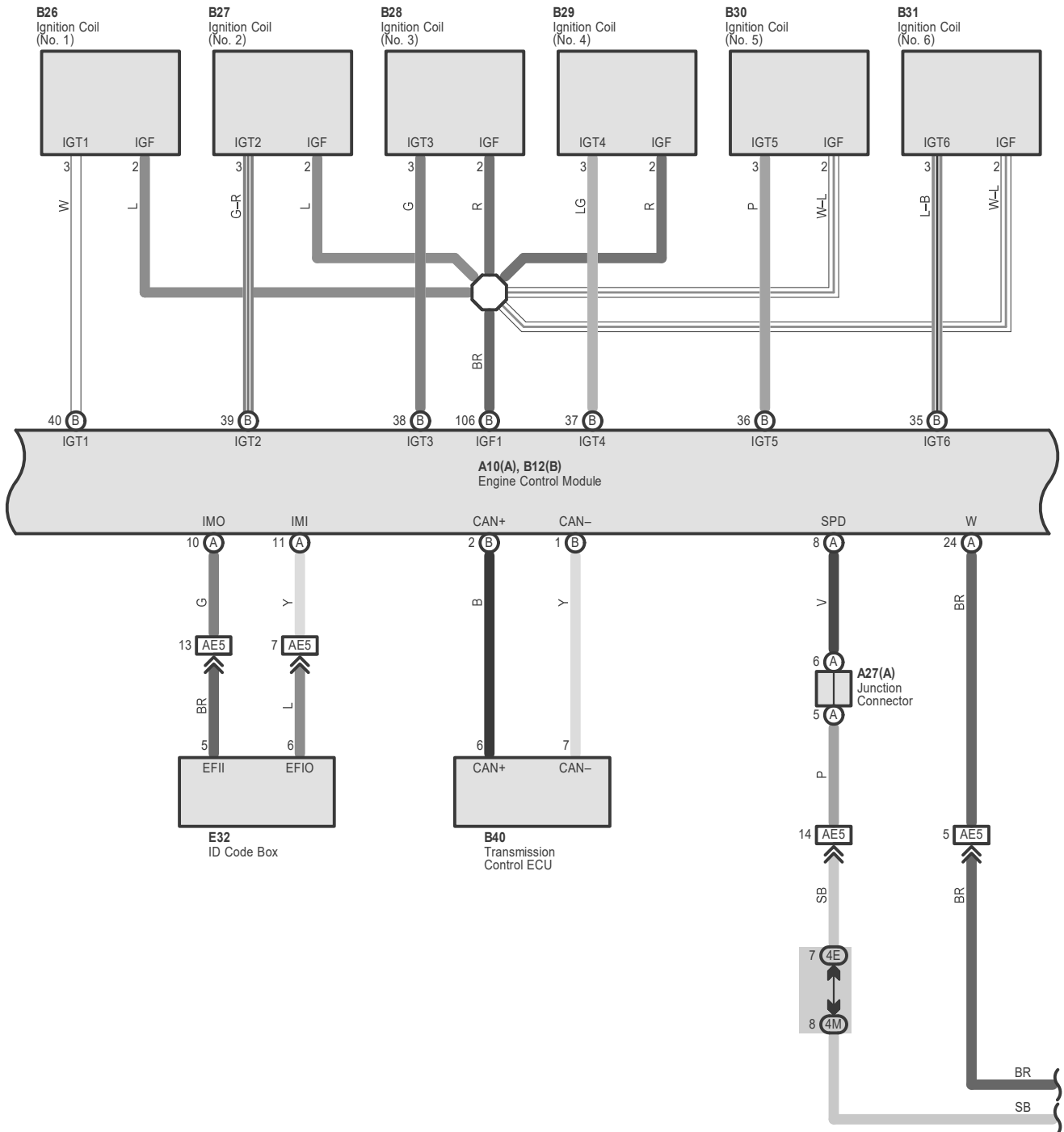



# Engine Control

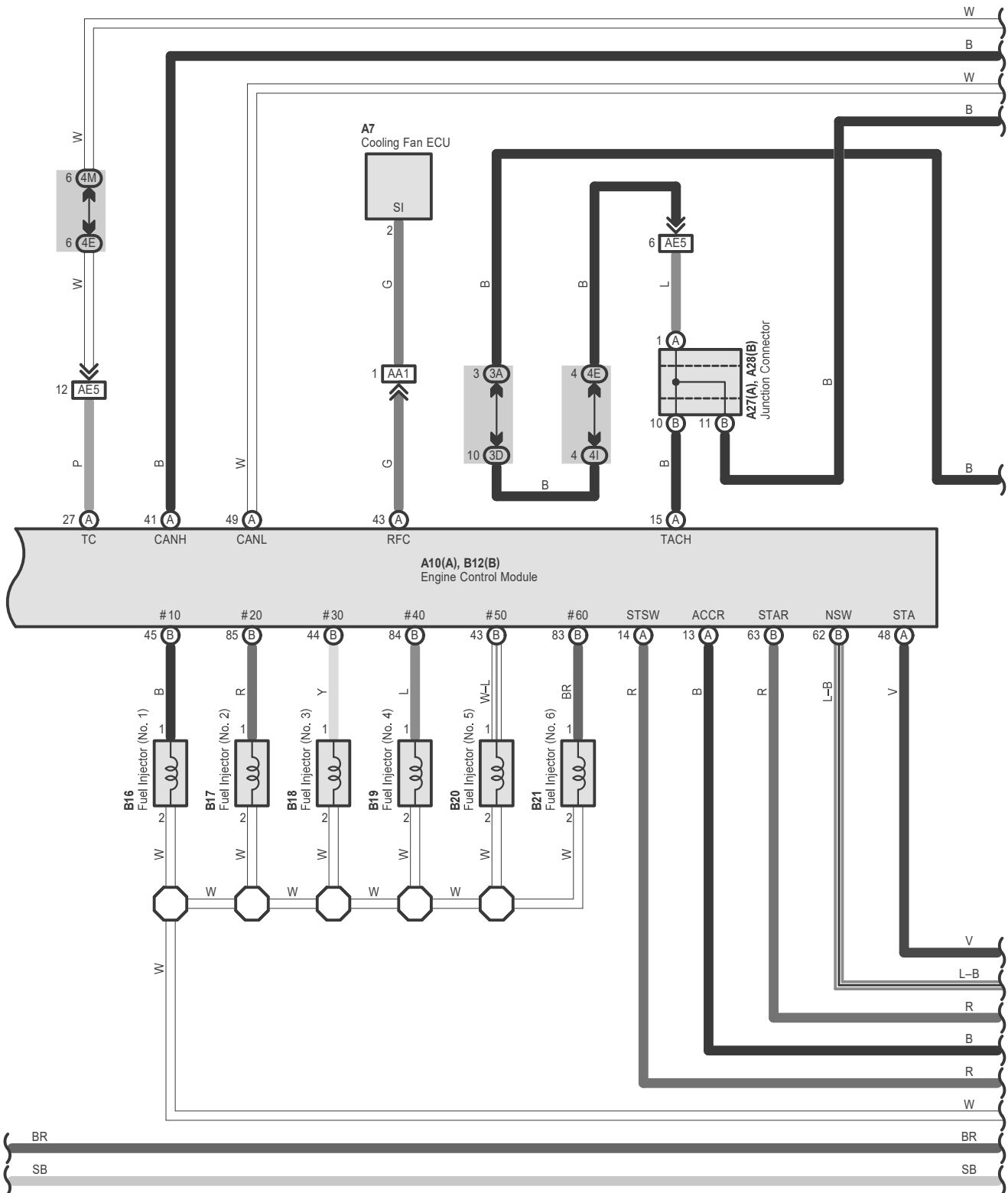

Engine Control

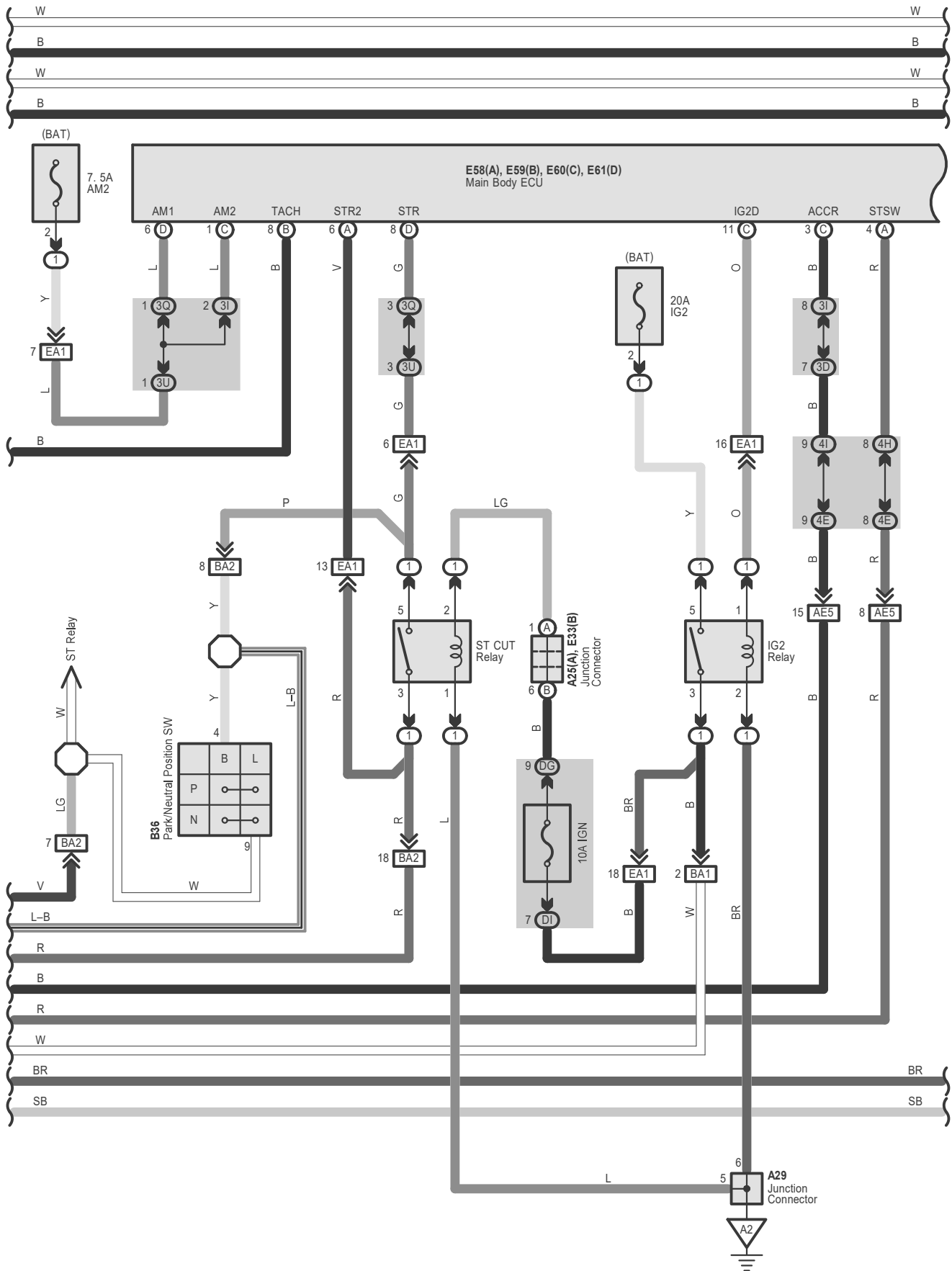

Engine Control

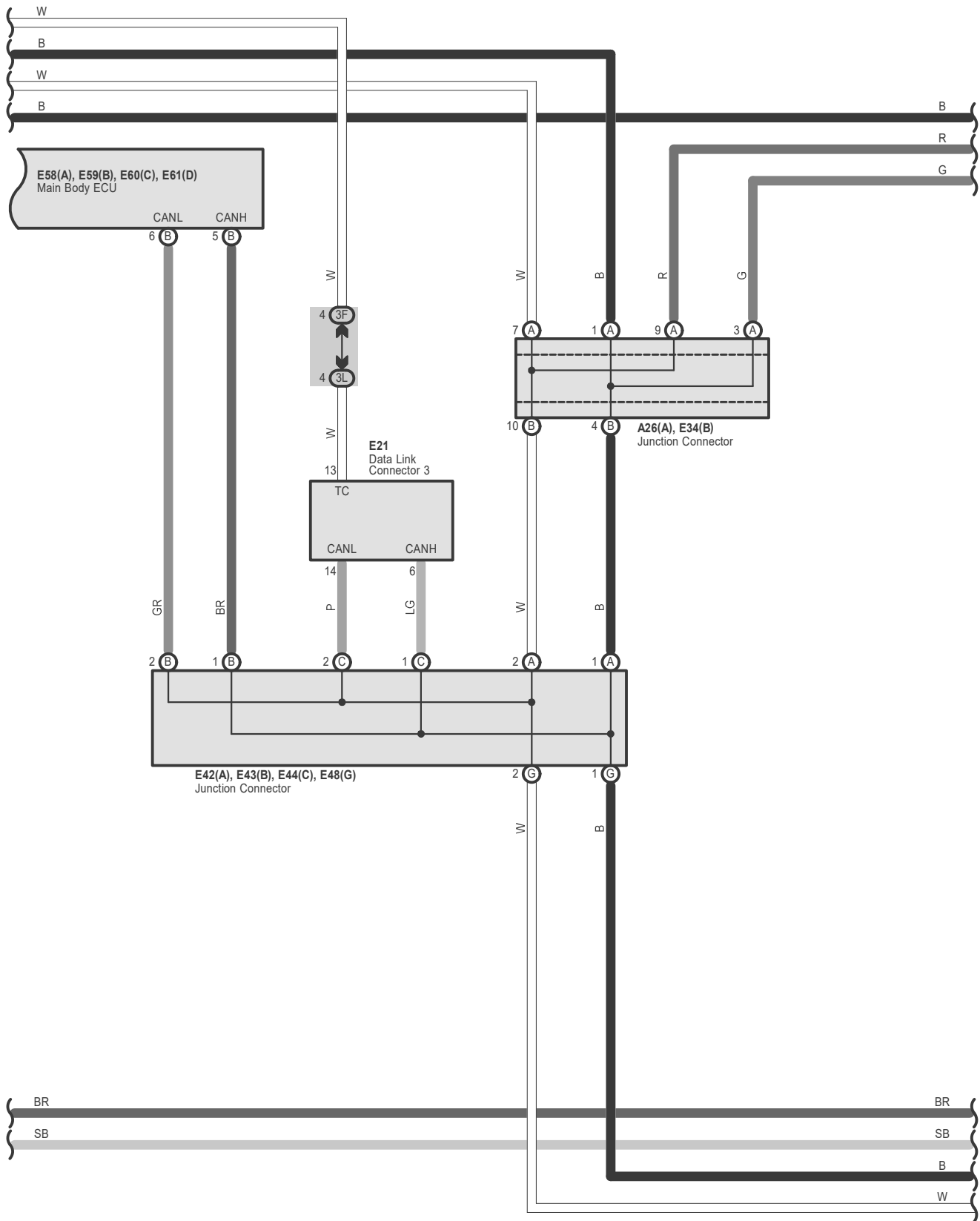

Engine Control

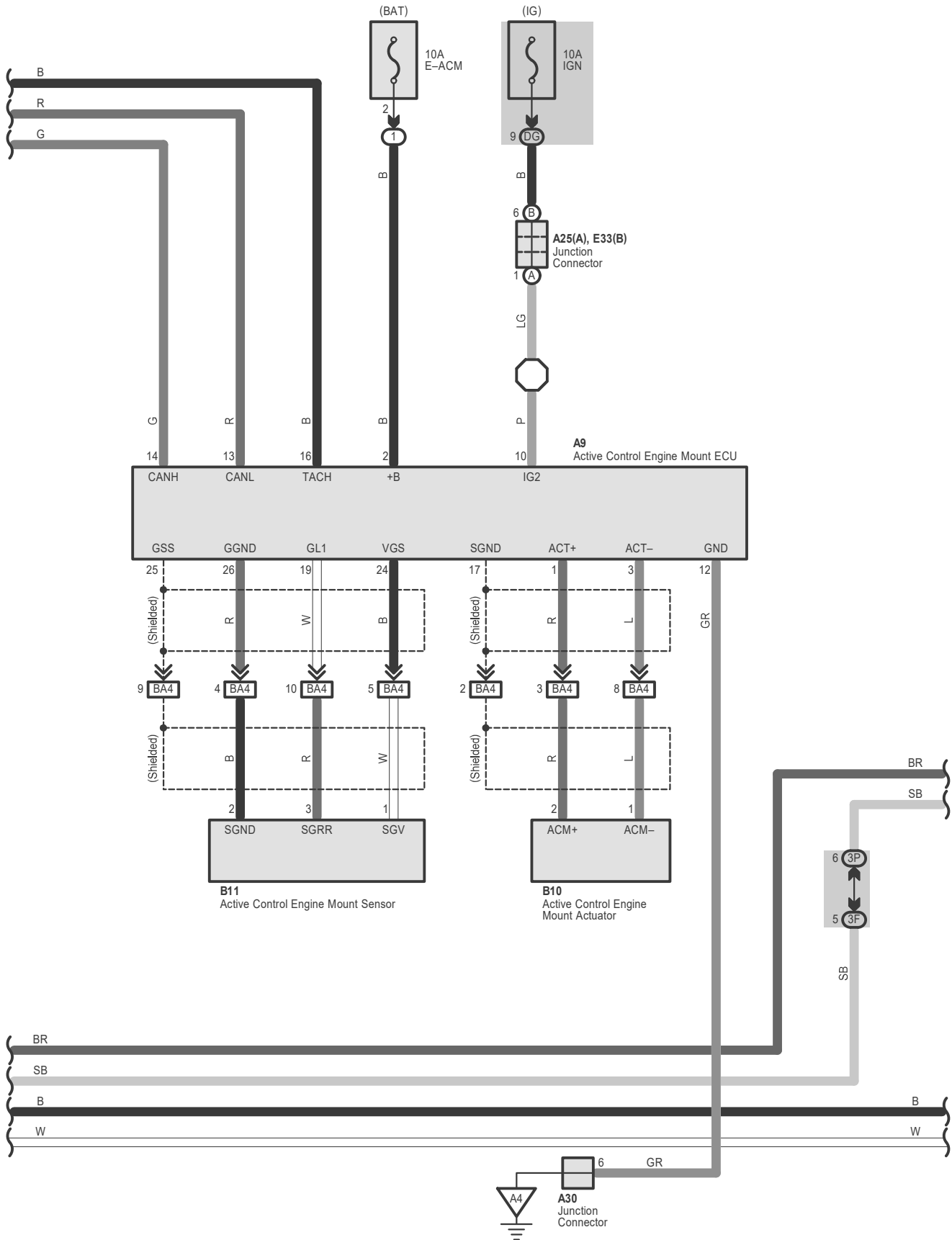

Engine Control

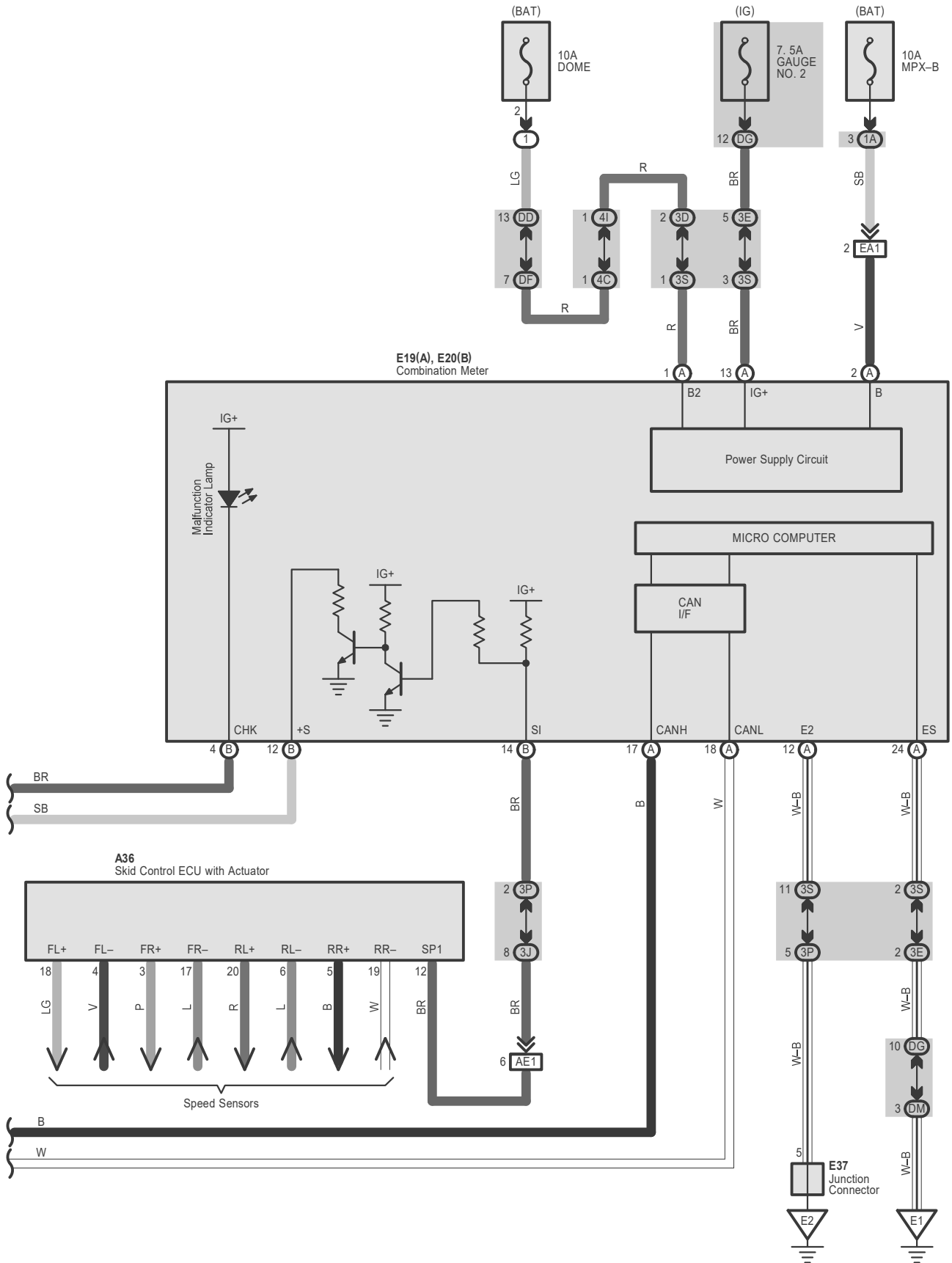

Engine Control

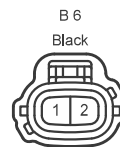
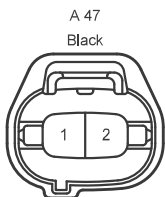
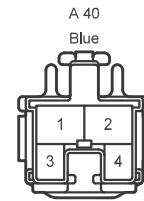
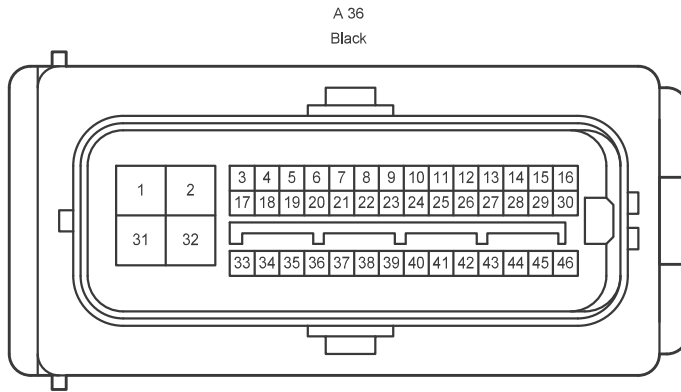
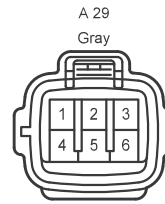
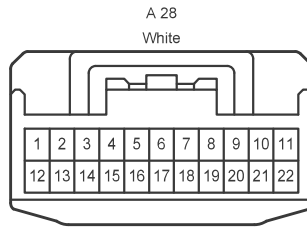
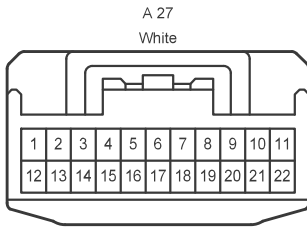
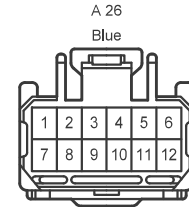
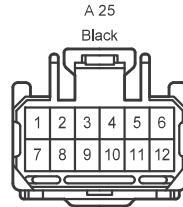
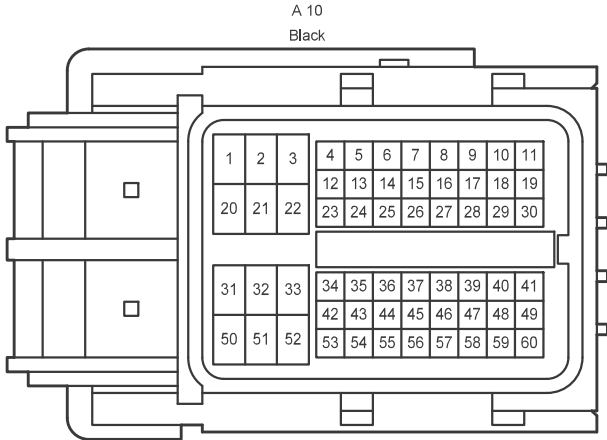
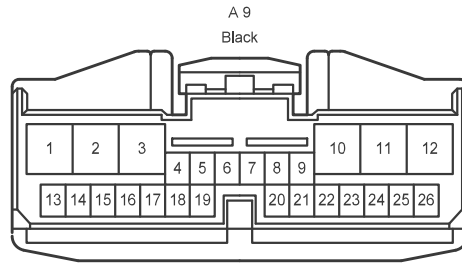
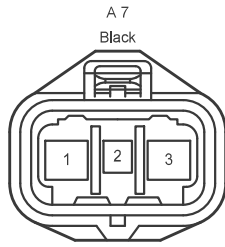
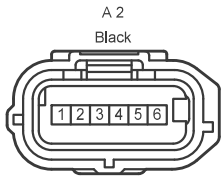

# Engine Control

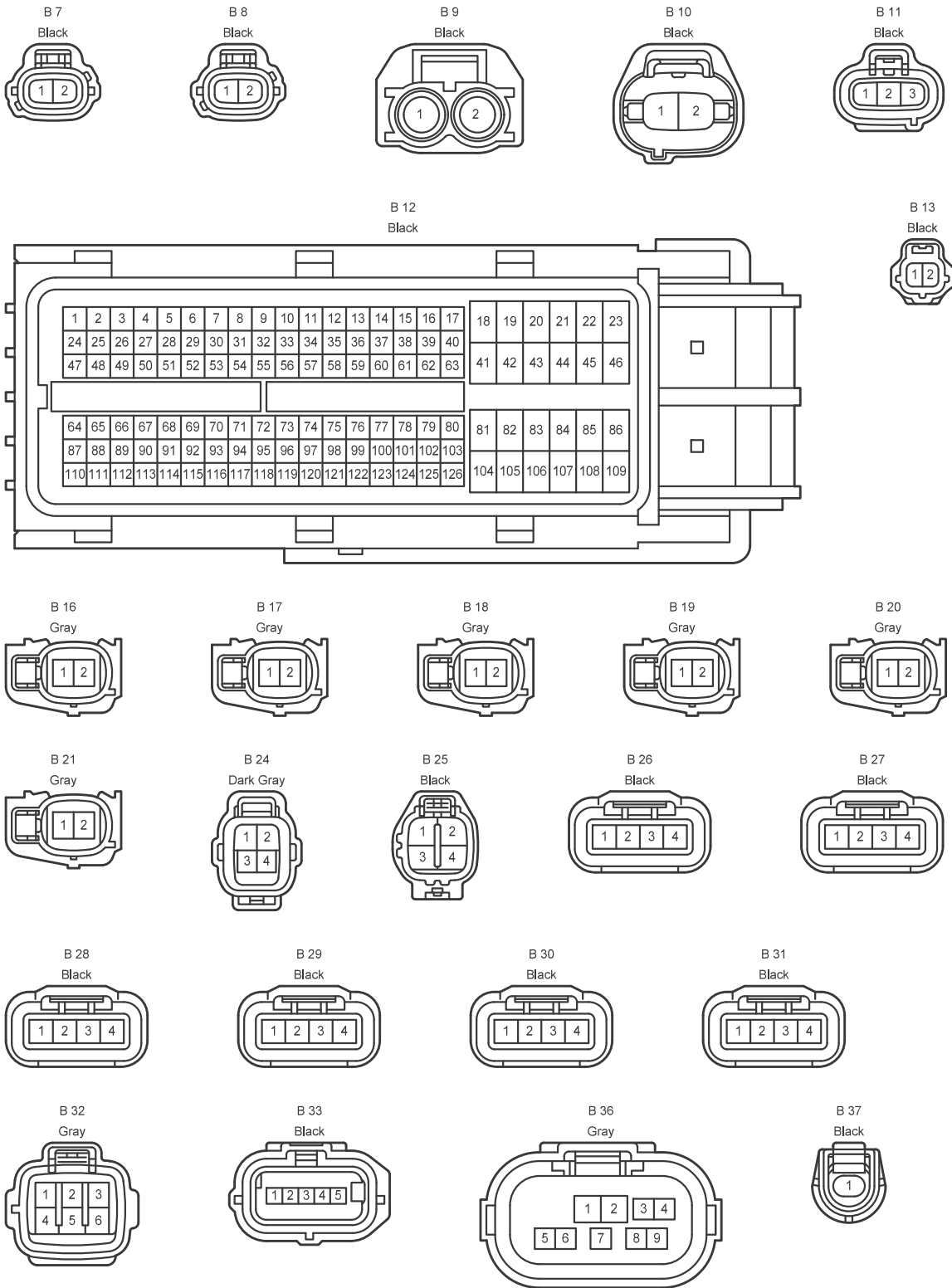

Engine Control

B 39  
Black

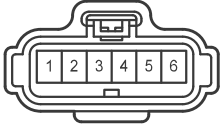

B 40  
Black

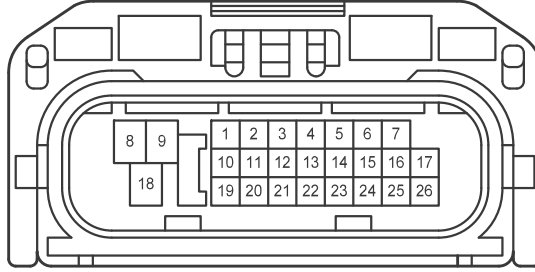

B 41  
Gray



B 42  
Black



B 43  
Black



B 44  
Black



B 45  
Black



B 46  
Black



E 19  
White

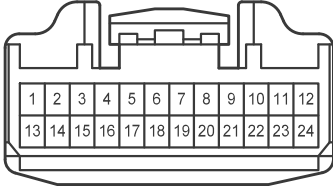

E 20  
White

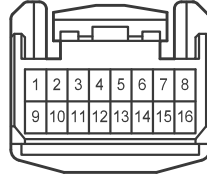

E 21  
Black

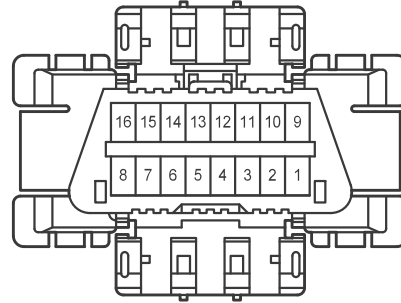

E 32  
White

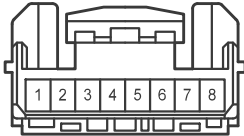

E 33  
Black

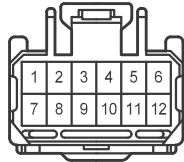

E 34  
Blue

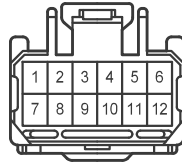

E 37  
White



E 42  
White

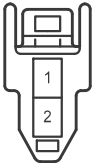

E 43  
White

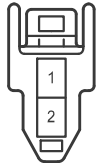

E 44  
White

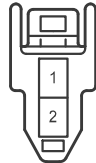

E 48  
White

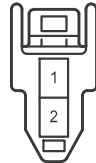

E 58  
White

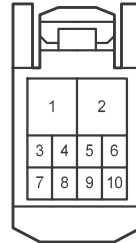

E 59  
White

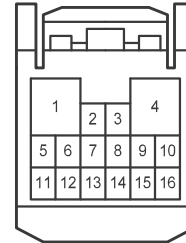



Engine Control

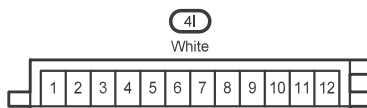
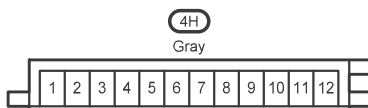
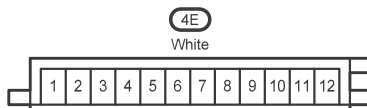
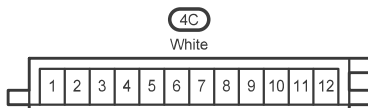
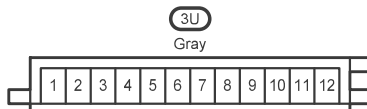
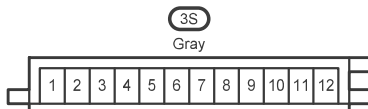
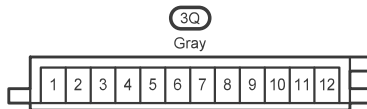
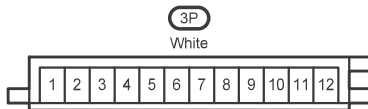
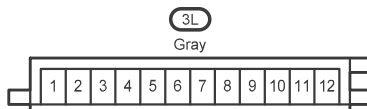
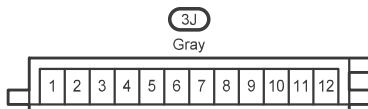
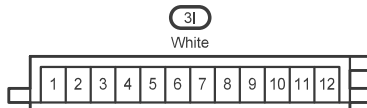
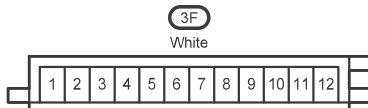
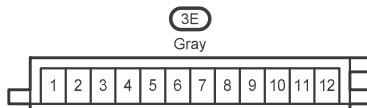
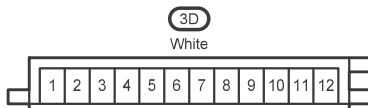
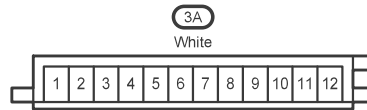
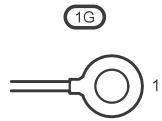
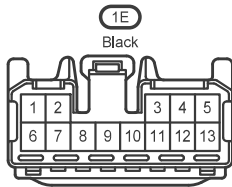
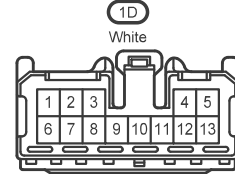
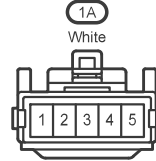
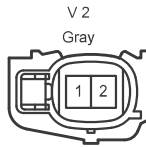
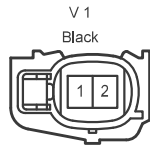
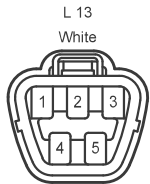
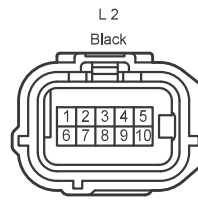
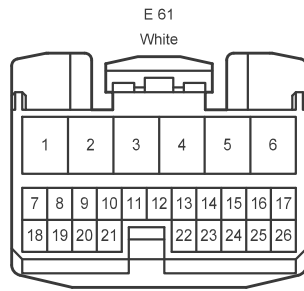
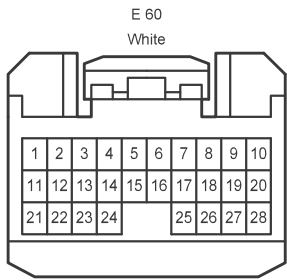

Engine Control

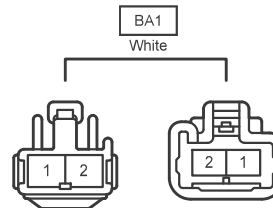
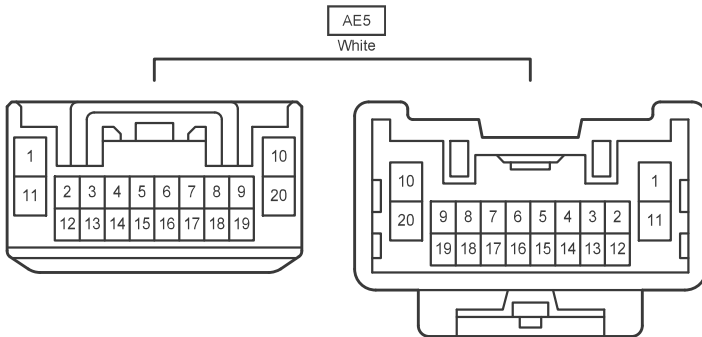
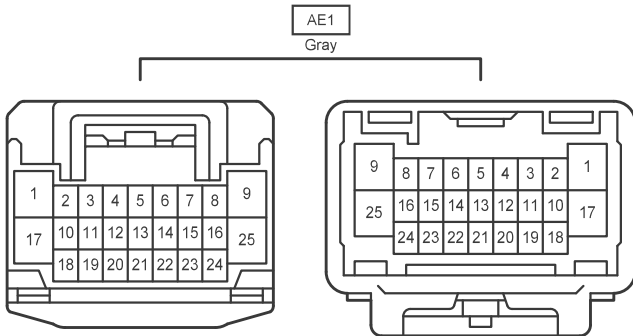
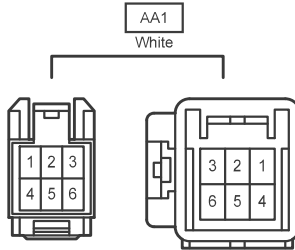
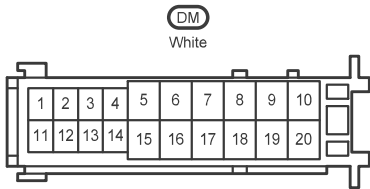
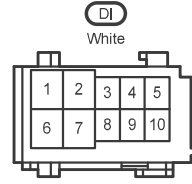
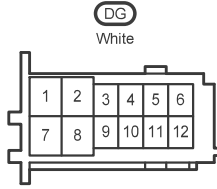
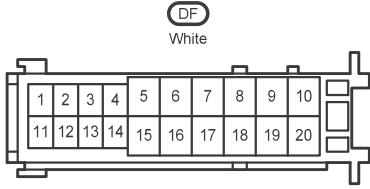
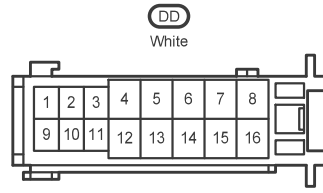
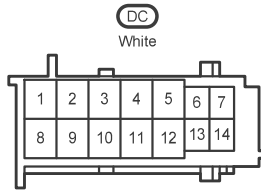
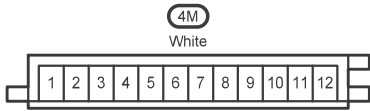

# Engine Control

