

**Part Number: Tuner Assy 86180-0W030  
Mounting Kit 86100-0W190**

**NOTE:** Part number of this accessory may not be the same as the part number shown.

**Tuner Assy Kit Contents (86180-0W030)**

Item #	Quantity Req'd.	Description
1	1	TUNER ASSY, STEREO COMPONENT

**Mounting Kit Contents (86100-0W190)**

Item #	Quantity Req'd.	Description
1	1	Wire, To Radio Installation
2	1	Bracket, Radio Receiver A
3	1	Bracket, Radio Receiver B
4	1	Antenna

**Hardware Bag Contents 1 (86100-0W190)**

Item #	Quantity Req'd.	Description
1	2	Cushion Tape (50mm×100mm)
2	5	Tie Wrap
3	1	Clamper

**Hardware Bag Contents 2 (86100-0W190)**

Item #	Quantity Req'd.	Description
1	4	Screw (M5×L8)
2	3	Nut (M6·Flange)

**Hardware Bag Contents 3 (86100-0W190)**

Item #	Quantity Req'd.	Description
1	1	Template
2	1	Nylon Tape (30mm×30mm)(Silver)
3	6	Nylon Tape (30mm×30mm)(Black)
4	1	Tie Wrap
5	1	Cushion Tape (20mm×100mm)
6	1	Cord Rail

**Additional Items Required For Installation**

Item #	Quantity Req'd.	Description

**Conflicts**

--

**Recommended Tools**

Personal & Vehicle Protection	Notes
Vehicle Protection	Clean Cloths, Part Boxes
Special Tools	Notes
None	

Installation Tools	Notes
Panel Clip Removal Tool	e.g. Toyota SST P/N:- 00002-06002-01
Socket	10mm
Screwdriver	Phillips, #2
Wrench	Open End, 10mm
Torque Wrench	36 lbf · in
Side Cutter	
Masking tape	
Special Chemicals	Notes
Cleaner	VDC approved cleaner and cleaning method

**General Applicability**

--

**Recommended Sequence of Application**





Item #	Accessory

\*Mandatory

**Vehicle Service Parts** (may be required for reassembly)

Item #	Quantity Req'd.	Description

**Legend**

	<b>STOP:</b> Damage to the vehicle may occur. Do not proceed until process has been complied with.
	<b>OPERATOR SAFETY:</b> Use caution to avoid risk of injury.
	<b>CAUTION:</b> A process that must be carefully observed in order to reduce the risk of damage to the accessory/vehicle and to ensure a quality installation.
	<b>TOOLS &amp; EQUIPMENT:</b> Used in Figures calls out the specific tools and equipment recommended for this process.

Parts Description of Tuner Assy (86180-0W030)

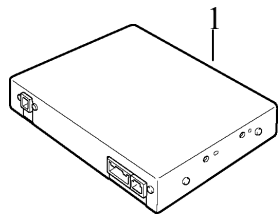

Item #	Parts Name	Parts No.	Qty
1	TUNER ASSY, STEREO COMPONENT ★	86180-0W030	1

★ In the installation instructions and figures, this is referred to as “Tuner”.

Parts Description of Mounting Kit (86100-0W190)

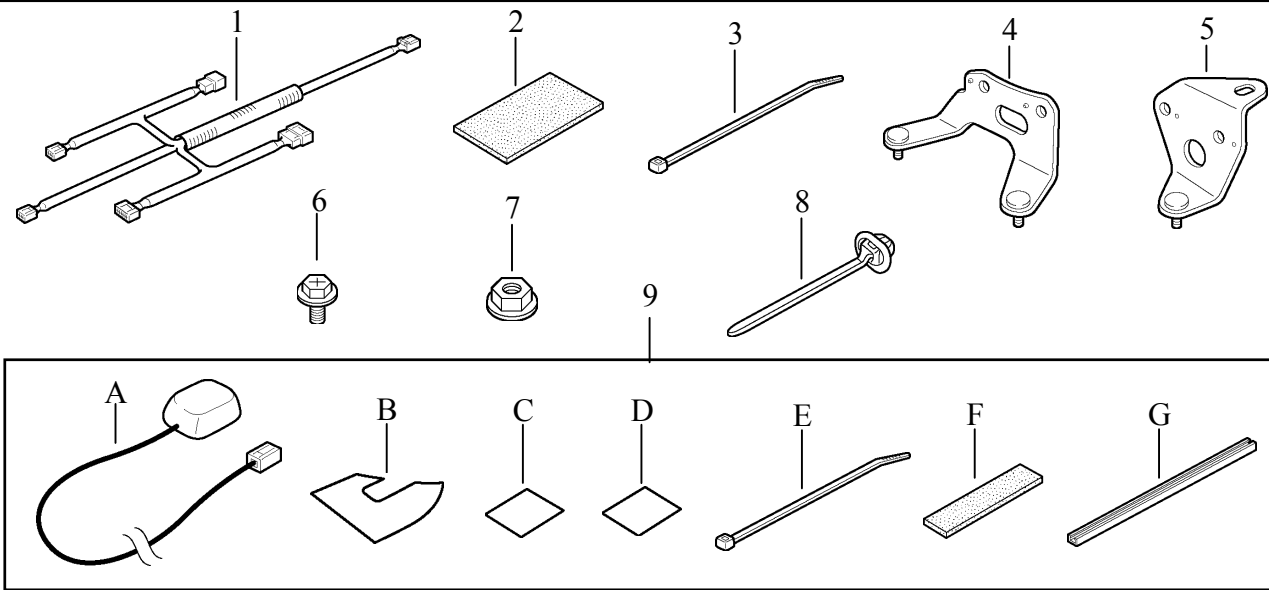

Item #	Parts Name	Parts No.	Qty
1	Wire, To Radio Installation ★1	82372-0W100	1
2	Cushion Tape (50mm×100mm)	—	2
3	Tie Wrap	—	5
4	Bracket, Radio Receiver A ★2	86215-0W160	1
5	Bracket, Radio Receiver B ★3	86215-0W170	1
6	Screw (M5×L8)	90153-50010	4
7	Nut (M6 · Flange)	90080-17185	3
8	Clammer	—	1
9	A Antenna	86960-0W040 ANTENNA ASSY, SATELLITE RADIO	1
	B Template		1
	C Nylon Tape (30mm×30mm)(Silver)		1
	D Nylon Tape (30mm×30mm)(Black)		6
	E Tie Wrap		1
	F Cushion Tape (20mm×100mm)		1
	G Cord Rail		1

- ★ 1 In the installation instructions and figures, this is referred to as “Tuner Cable”.
- ★ 2 In the installation instructions and figures, this is referred to as “Tuner Bracket A”.
- ★ 3 In the installation instructions and figures, this is referred to as “Tuner Bracket B”.

Care must be taken when installing this accessory to ensure damage does not occur to the vehicle. The installation of this accessory should follow approved guidelines to ensure a quality installation.

These guidelines can be found in the "Accessory Installation Practices" document.

This document covers such items as:-

- Vehicle Protection (use of covers and blankets, cleaning chemicals, etc.).
- Safety (eye protection, rechecking torque procedure, etc.).
- Vehicle Disassembly/Reassembly (panel removal, part storage, etc.).
- Electrical Component Disassembly/Reassembly (battery disconnection, connector removal, etc.).

Please see your Lexus dealer for a copy of this document.

**1. Vehicle Protection.**

- (a) Set emergency hand brake.
- (b) Remove the negative battery cable.
  - (1) Protect the fender before starting.
  - (2) Remove the battery cover (Fig. 1-1).

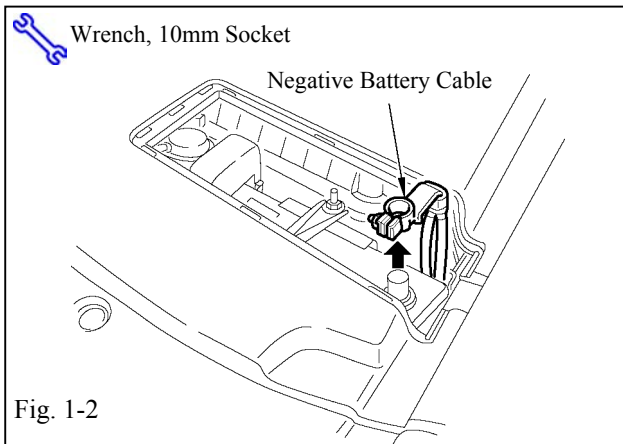
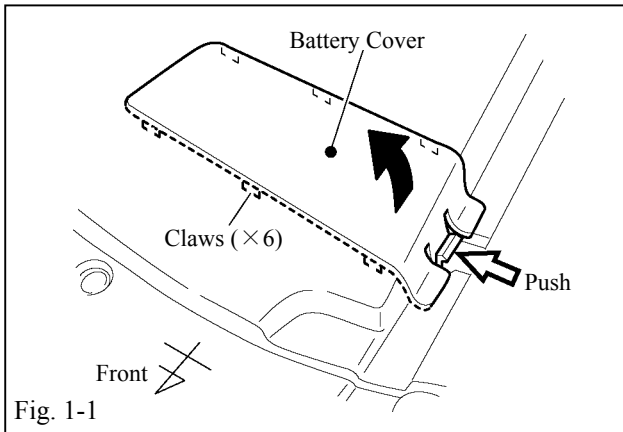

- (3) Do not touch the positive terminal with any tool when removing cable (Fig. 1-2).
- (c) Wait 90 seconds before proceeding to disassemble vehicle.

## 2. Disassembly of Vehicle.



**NOTE:** Place all removed parts on a protected surface.

**NOTE:** When disconnecting wiring connectors do not pull on the wiring, pull on the connector only.

(a) Partially remove the trunk door trim.

(1) Remove the 5 clips (A) and 1 clip (B).  
(Fig. 2-1).

(2) Partially remove the trim. (Fig. 2-1).

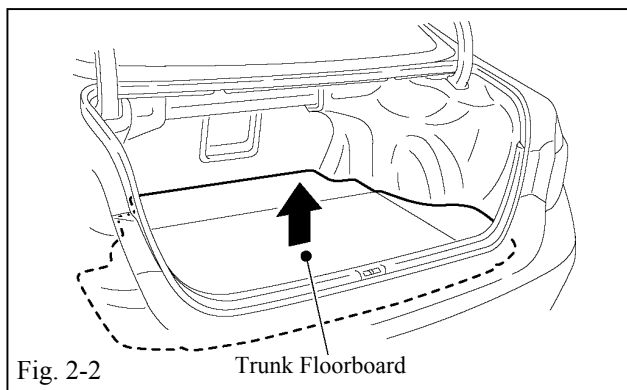
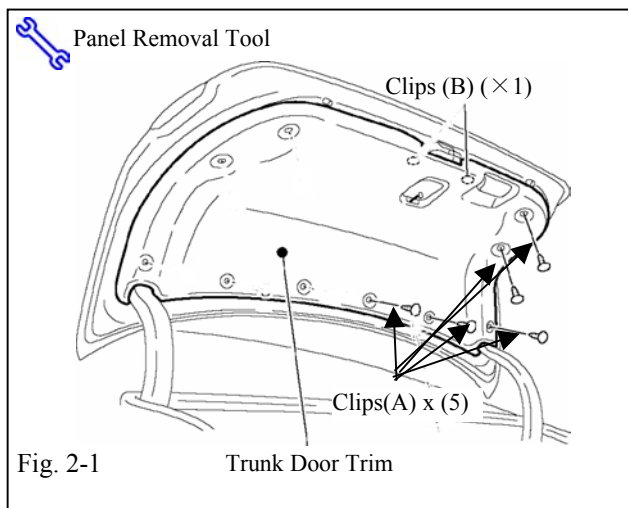

(b) Remove the trunk floorboard (Fig. 2-2).

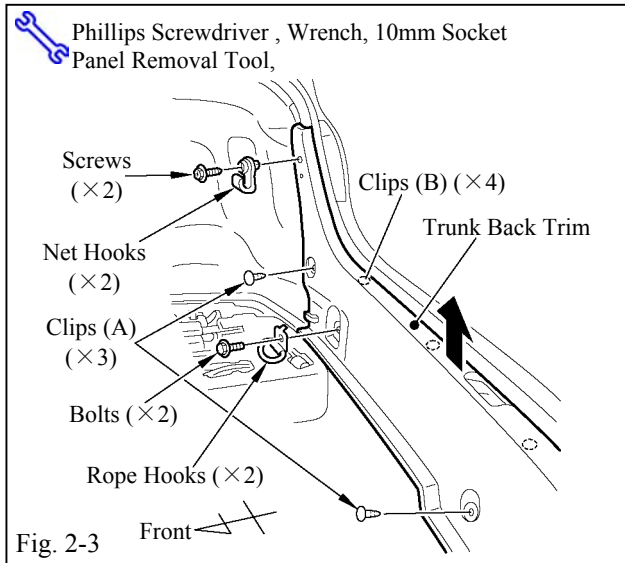

(c) Remove the trunk back trim (Fig. 2-3).

**NOTE:** The right side is shown in the figure, but the procedure is the same for the left side.

- (1) Remove the screws and the net hooks (R/L).
- (2) Remove the bolts and the rope hooks (R/L).
- (3) Remove the clips (A).
- (4) Pull the trim in the direction of the arrow as shown in the figure and remove the clips (B).

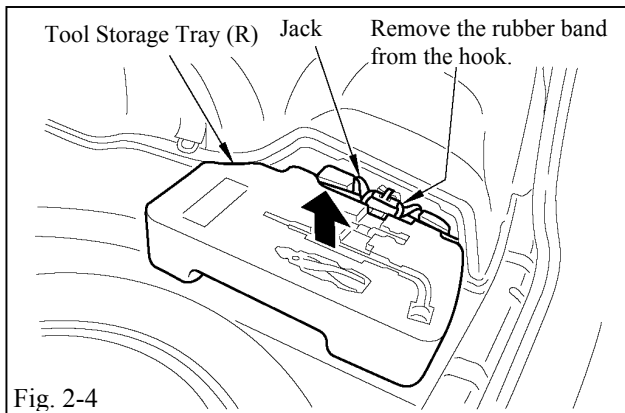

(d) Remove the tool storage tray (R) and the jack (Fig. 2-4).

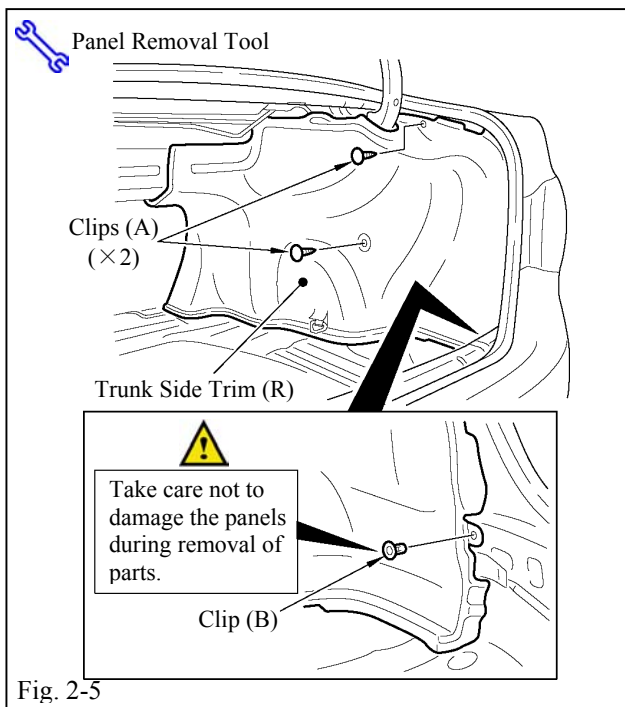

(e) Remove the trunk side trim (R) (Fig. 2-5).

- (1) Remove the two clips (A).
- (2) Remove the clip (B).
- (3) Pull the trim away from panel and remove it.

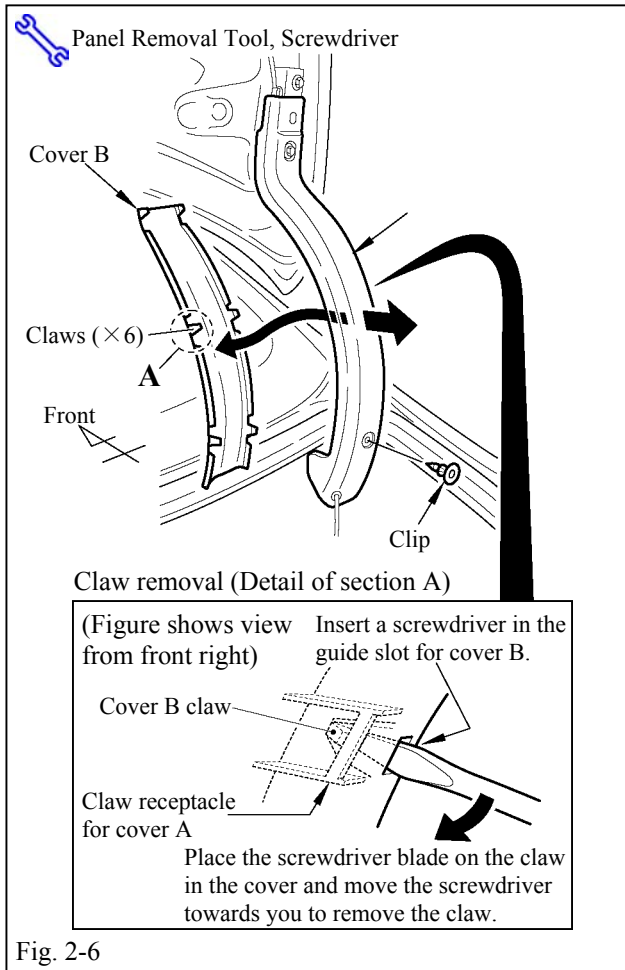

Fig. 2-6

- (f) Remove the trunk door hinge cover (R) (Fig. 2-6).
  - (1) Remove cover B from cover A.
  - (2) Remove the clip, and then remove cover A from door hinge.

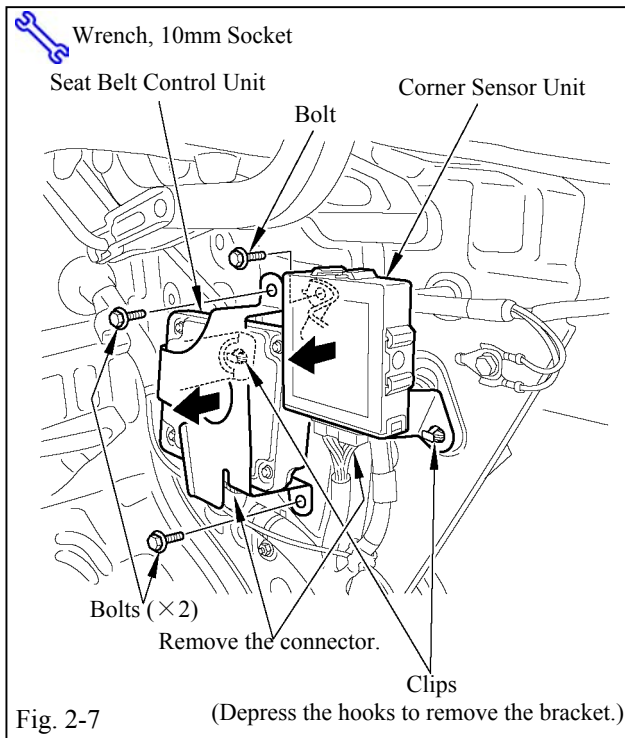
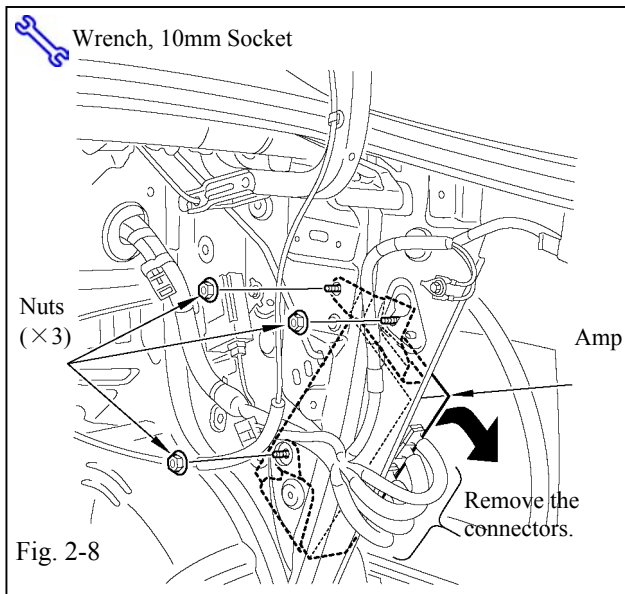

Fig. 2-7

- (g) Remove the corner sensor unit (if equipped) from the trunk side panel (R) (Fig. 2-7)
  - (1) Remove the bolt and then remove the clip retainer.
  - (2) Remove the wire connector.
- (h) Remove the seat belt control unit (if equipped) from the trunk side panel (R) (Fig. 2-7)
  - (1) Remove the bolt and then remove the clip retainer.
  - (2) Remove the wire connector.



- (i) Remove the amp from the trunk side panel (R) (Fig. 2-8).

**NOTE :** The indications in the figure are for a standard audio amp but they are the same for Mark Levinson audio amp.

- (1) Remove the wire connectors.
- (2) Remove the three nuts.

### 3. Antenna Installation and Wiring.

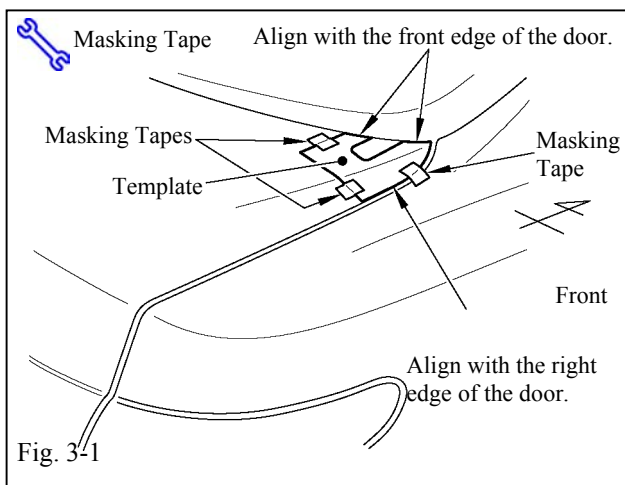

- (a) As shown in the figure 3-1, place the template on the front right side of the trunk door and use masking tape to temporarily attach it (Fig. 3-1).

**NOTE:** Fasten as described in the explanation printed on the template.

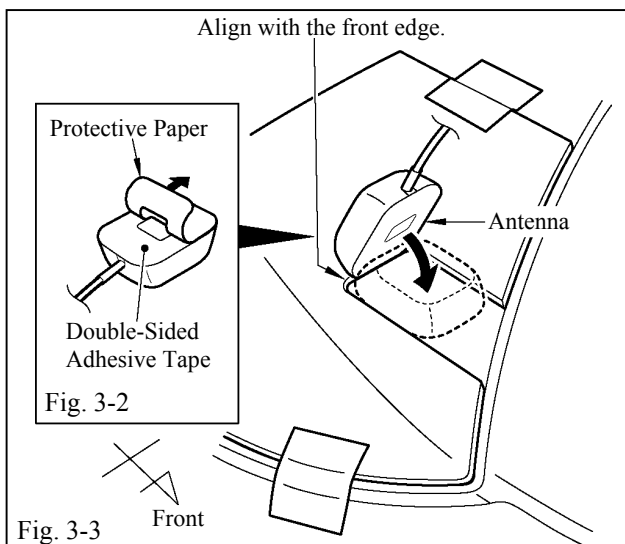

- (b) Peel off the protective paper from the double-sided adhesive tape on the base of the antenna (Fig. 3-2).



- (c) Before sticking on the antenna, wipe the door surface clean to remove dirt and oil using VDC approved cleaner.

- (d) Align the front edge of the antenna with the template as indicated in the figure, and rotate the antenna downwards to stick on (Fig. 3-3).



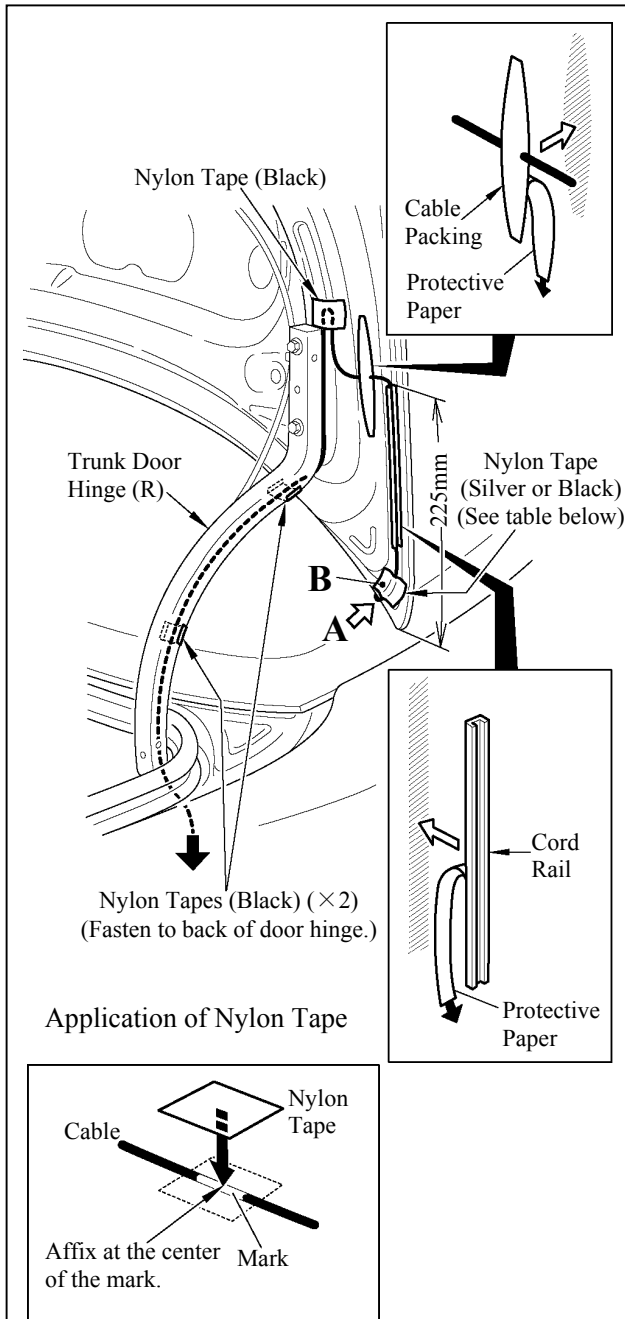

Fig. 3-4 Nylon Tape B Color Correlation Chart

Body color	Black	Silver
062 (white Pearl Crystal Shine)		○
1G1 (Silver Mica Metallic)		○
1G0 (Dark Gray Mica )	○	
202 (Black)	○	
3R5 (Dark Red Mica CC.)	○	
3R4 (Shell Mica Metallic)	○	
4T1 (Beige Metallic)		○
4T0 (Blond Mica Metallic)	○	
778 (Dark Turquoise Mica Metallic)	○	
8P8 (Dark Blue Mica)	○	

(e) Wire the antenna cable from the trunk door to the door hinge (Fig. 3-4).



(1) Carefully wipe away any dirt or oil from surfaces where cord rails, nylon tape and cable packing are to be attached in the following steps using VDC approved cleaner.

(2) Attach a cord rail at the location on the rear side of the door shown in the figure (Fig. 3-4).

(3) Route the antenna cable through the cord rail and secure it with nylon tape (B in the figure) (Fig. 3-4).



**NOTE :** Use tape for nylon tape B in the figure of a color that matches the body color by referring to the table in the figure (Fig. 3-4).

**NOTE :** When fastening nylon tape, fasten at the center of the mark on the cable. (This applies similarly to all subsequent work.)



**NOTE :** Be careful not to apply unreasonable force at the section marked A in the figure when pulling the cable.

(4) Stick cable packing on the rear side of the door in the position shown in the figure (Fig. 3-4).



**NOTE :** Stick down in a position where the cable packing and weather strip touch when the door is closed.

(5) As shown in the figure (Fig 3-4), route the cable in the door hinge and secure it with black nylon tape.

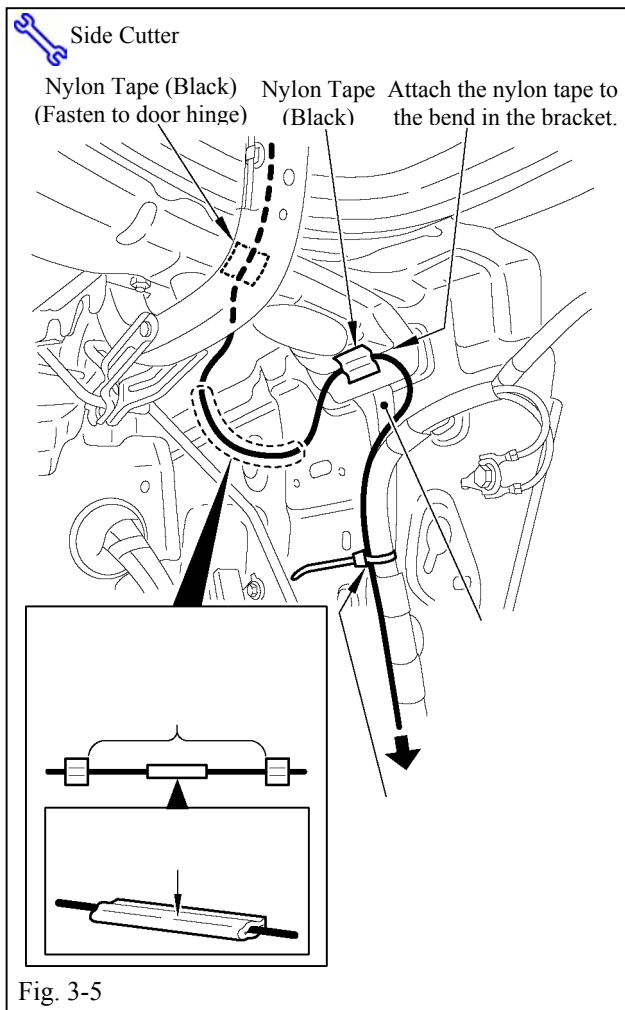

(f) Run the antenna cable into the trunk room and fasten with black nylon tape at the location shown in the figure (Fig. 3-5).



(1) Before sticking on the nylon tape, wipe the body surface clean to remove dirt and oil using VDC approved cleaner.

(g) Wrap cushion tape around the antenna cable at the location shown in the figure (Fig. 3-5).

(h) Secure the amp harness with a tie wrap at the location shown in the figure (Fig. 3-5).

(i) Cut off excess tie wrap with a side cutter.

#### 4. Tuner Connection and Installation.

(a) Attach the tuner to tuner brackets A and B (Fig. 4-1).

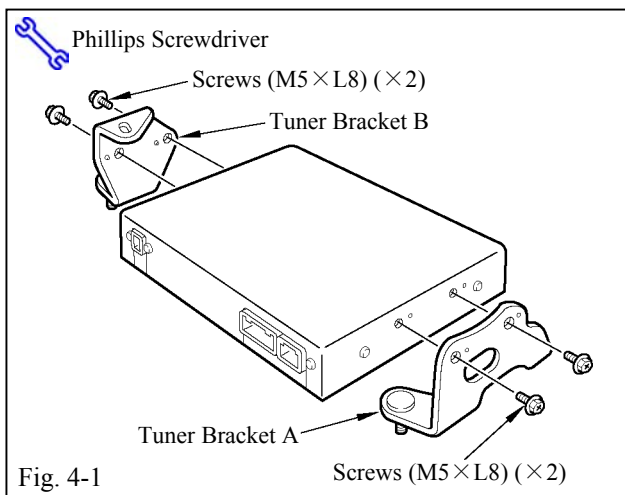

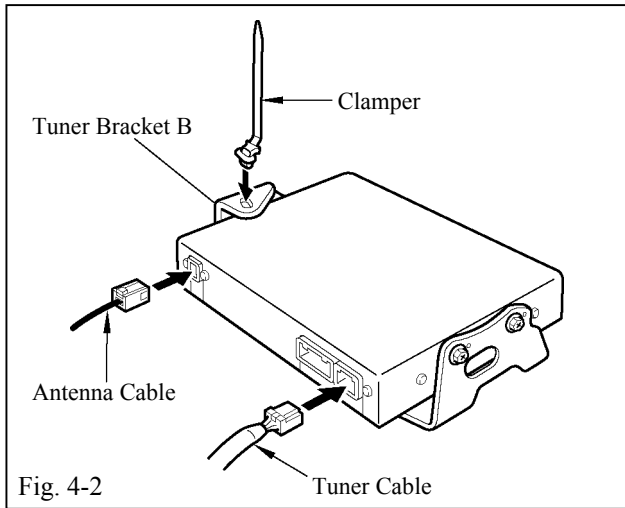

- (b) Connect the antenna cable and tuner cable to the tuner (Fig. 4-2).
- (c) Insert a clamer in tuner bracket B (Fig. 4-2).

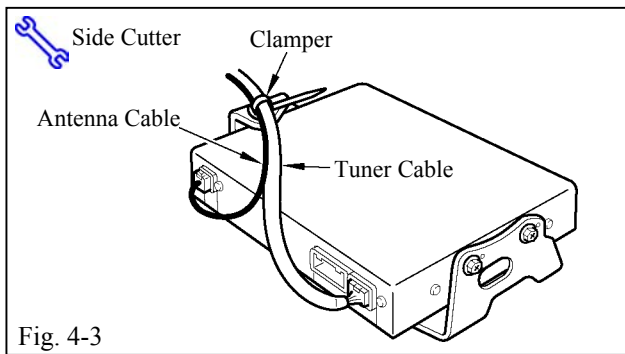

- (d) Secure the tuner cable and antenna cable with the clamer (Fig. 4-3).
- (e) Cut off excess clamer with a side cutter.

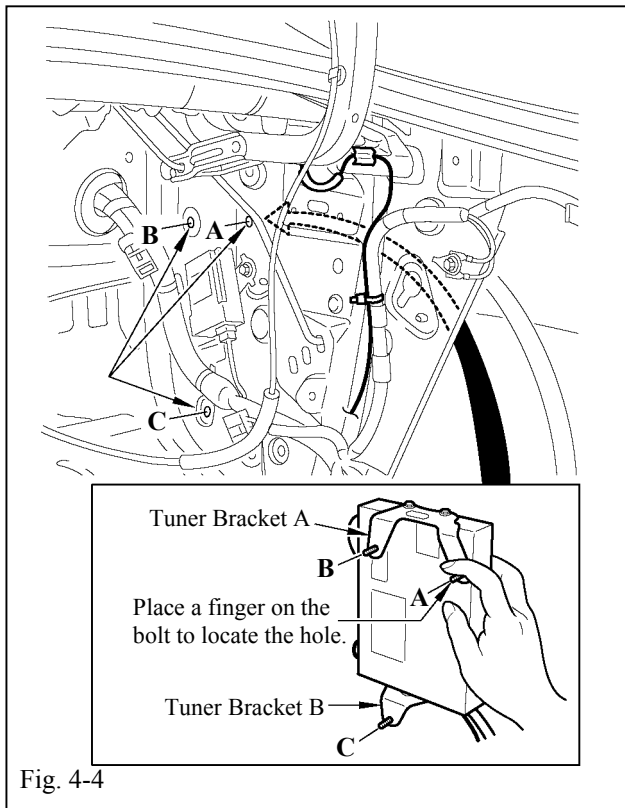

- (f) Attach the tuner to the trunk side panel.
- NOTE :** The instructions provided in the figure are for a standard audio amp but they are the same for a Mark Levinson audio amp.

- (1) Insert the tuner on the rear of the side panel and place the bracket bolts in the three mounting holes (Fig. 4-4).

**NOTE :** As shown in the figure, place a finger on the bolt to locate the hole in the side panel to facilitate insertion.

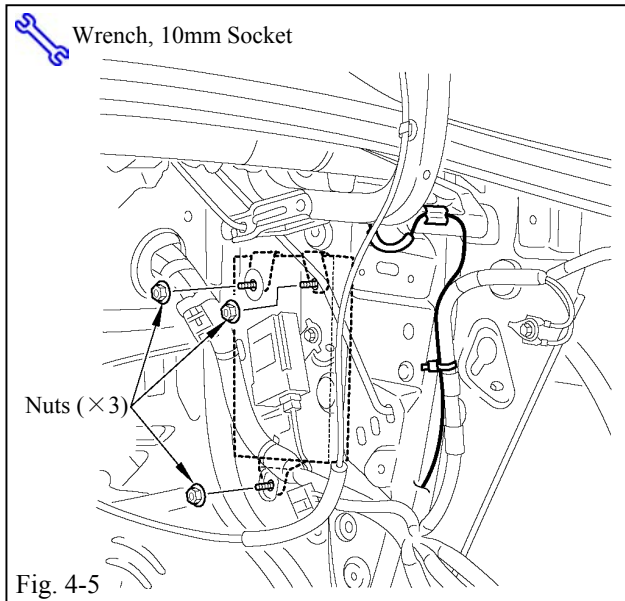

(2) Use nuts to secure (Fig. 4-5).

### 5. Tuner Cable and Antenna Cable Wiring.

(a) Connect the tuner cable to the harness as shown in the figure (Fig. 5-1).

**NOTE :** The figure shows the connections for a standard audio amp but they are the same for a Mark Levinson audio amp.

(b) Use tie wraps to secure the tuner cable and the antenna cable to the amp harness (Fig. 5-2).

(c) Cut off excess tie wrap with a side cutter.

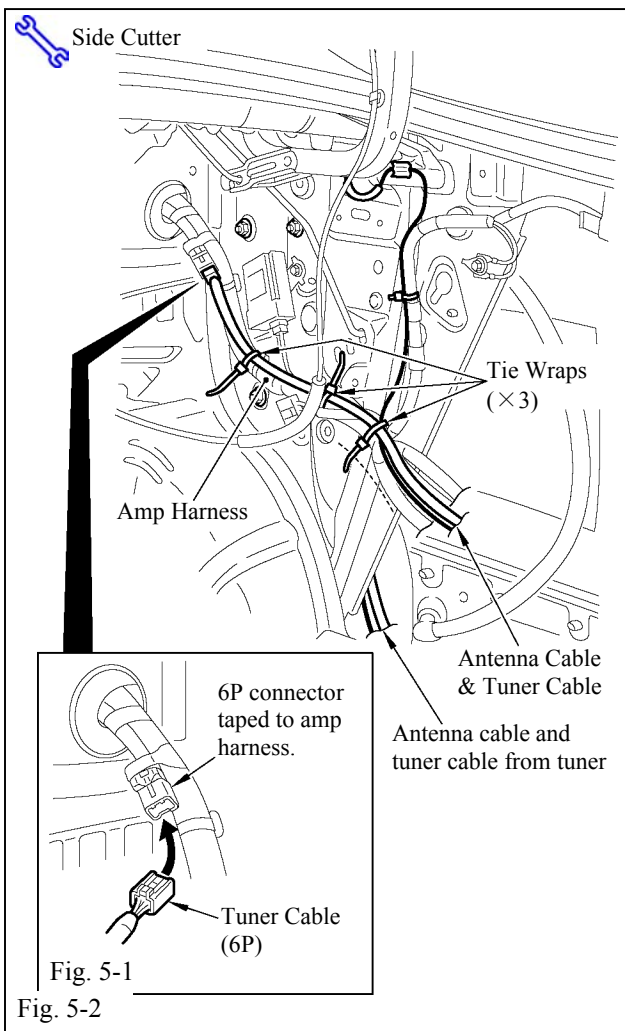

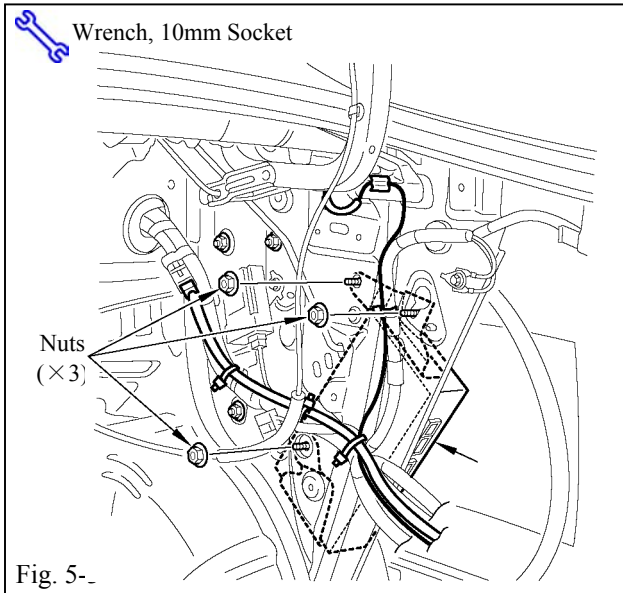

(d) Reattach the amp to the side panel (Fig. 5-3).

**NOTE :** The indications in the figure are for a standard audio amp but they are the same for Mark Levinson audio amp.

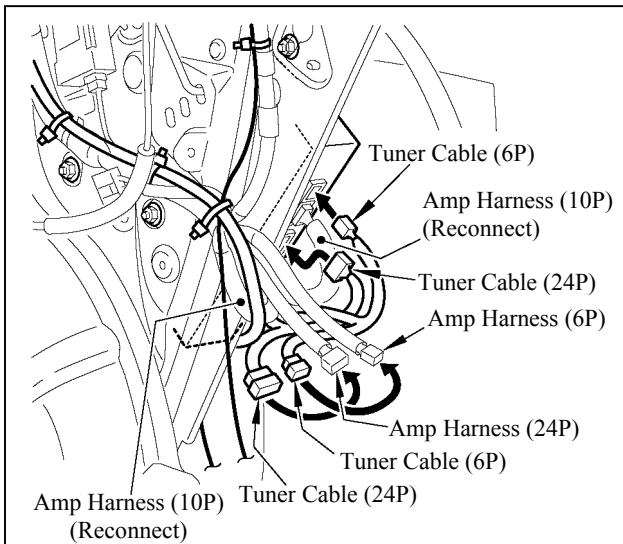

(e) Connect the amp harness (10P, 10P) of the standard audio amp to the amp (Fig. 5-4).

**NOTE :** The indications in the figure are for a standard audio amp. Connect the amp harness (10P, 10P, digital signal connector) of a Mark Levinson audio amp to the amp.

(f) Connect the tuner cable to the amp harness (24P, 6P) (Fig. 5-4).

(g) Connect the tuner cable to the amp (Fig. 5-4).

(h) Wrap cushion tape around locations where the connector is connected (Fig. 5-5).

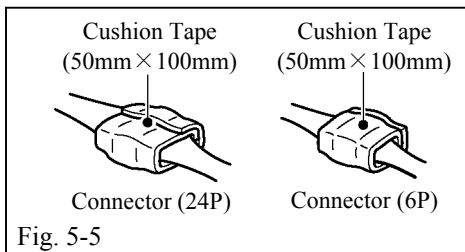

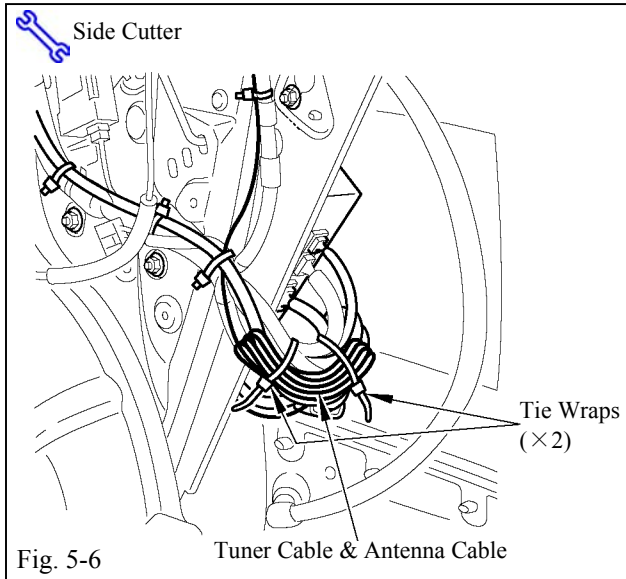

- (i) As shown in the figure, use tie wraps to bundle the entire length of the tuner cable and the antenna cable to the amp harness (Fig. 5-6).
- (j) Cut off excess tie wrap with a side cutter.

**NOTE :** The indications in the figure are for a standard audio amp but they are the same for Mark Levinson audio amp.

## 6. Completing the Installation.

- (a) Complete the reassembly of the vehicle.
  - (1) Reconnect any disconnected connectors.
  - (2) Verify the panels fit together properly with no uneven gaps between them.
- (b) Clean up and remove any trash.
- (c) Reconnect the vehicle's negative battery cable (Fig. 6-1).
  - (1) Position the negative terminal at the original factory position.
  - (2) Tighten the nut to 4.1N•m (36 lbf•in).
  - (3) Do not touch the positive terminal with any tool when replacing the cable.

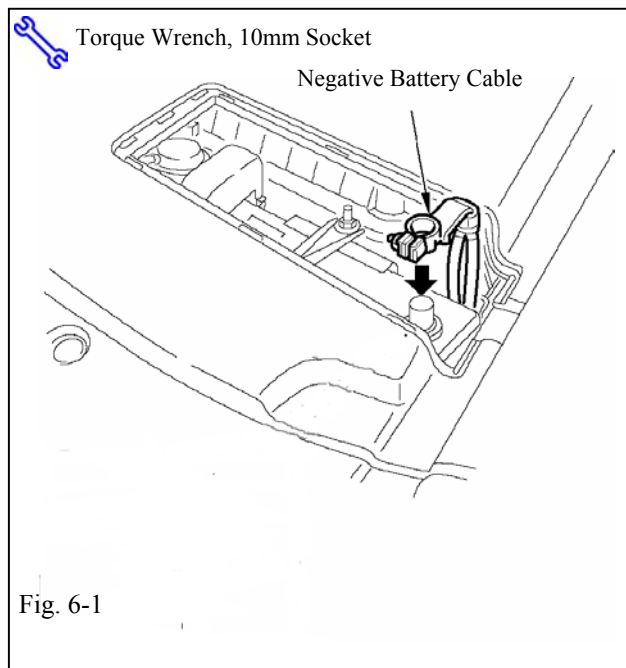

Checklist - these points **MUST** be checked to ensure a quality installation.

Check:

Look For:

Accessory Function Checks

- Verify the proper operation of the satellite radio tuner referring to the receiver assy and radio owner's manuals.
- Verify the proper operation of the receiver assy and radio referring to the receiver assy and radio owner's manuals.

Vehicle Function Checks

- Trunk Door Opener
- After the battery cable is reconnected, the functional components of the car need to be re-initialize. Initialize them with reference to RM0110U in the vehicle repair manual.

Functioning Door Opener