

Part Number: PTR07-77111
PTR07-76130

Kit Contents

Item #	Quantity Reqd.	Description
1	1	Front Sway Bar
2	1	Rear Sway Bar
3	1	Chassis Brace, Rear
4	1	Hardware Bag
5	1	Instructions

Hardware Bag Contents

Item #	Quantity Reqd.	Description
1	2	Front Bushings
2	2	Rear Bushings
3	2	Rear Sway Bar Brackets

Additional Items Required For Installation

Item #	Quantity Reqd.	Description
1		Light Oil (WD-40 or air tool oil)
2		
3		

Conflicts

None

Recommended Tools

Personal & Vehicle Protection	Notes
Safety Glasses	
Ear Plugs	
Special Tools	Notes
Installation Tools	Notes
Sockets	10, 12, 14, 17, 19, 21, 22mm
Impact Gun	3/8"
Open Wrench	10mm
Ratchet	3/8" & 1/2"
Torque Wrench	3/8" & 1/2"
Nylon Pry Tool	
Tape Measure	Inches
Special Chemicals	Notes
Light Oil	VDC Approved Lubricant

General Applicability

All 2011 and newer models

Recommended Sequence of Application

Item #	Accessory
1	Lowering Springs
2	Sway Bars
3	







*Mandatory

Vehicle Service Parts (may be required for reassembly)

Item #	Quantity Req'd.	Description
1	48830-12070	Link Assy, RR Stab*
2	94184-61001	Lock Nut*
3		

*Only if damaged during disassembly

Legend

	STOP: Damage to the vehicle may occur. Do not proceed until process has been complied with.
	OPERATOR SAFETY: Use caution to avoid risk of injury.
	CAUTION: A process that must be carefully observed in order to reduce the risk of damage to the accessory/vehicle and to ensure a quality installation.
	TOOLS & EQUIPMENT: Used in Figures calls out the specific tools and equipment recommended for this process.
	REVISION MARK: This mark highlights a change in installation with respect to previous issue.
	SAFETY TORQUE: This mark indicates that torque is related to safety.

Care must be taken when installing this accessory to ensure damage does not occur to the vehicle. The installation of this accessory should follow approved guidelines to ensure a quality installation.

These guidelines can be found in the "Accessory Installation Practices" document.

This document covers such items as:-

- Vehicle Protection (use of covers and blankets, cleaning chemicals, etc.).
- Safety (eye protection, rechecking torque procedure, etc.).
- Vehicle Disassembly/Reassembly (panel removal, part storage, etc.).
- Electrical Component Disassembly/Reassembly (battery disconnection, connector removal, etc.).

Please see your Lexus dealer for a copy of this document.

1. Remove the OE Front Sway Bar.

- (a) Remove the **driver side** front wheel.
- (b) Remove the engine under cover.

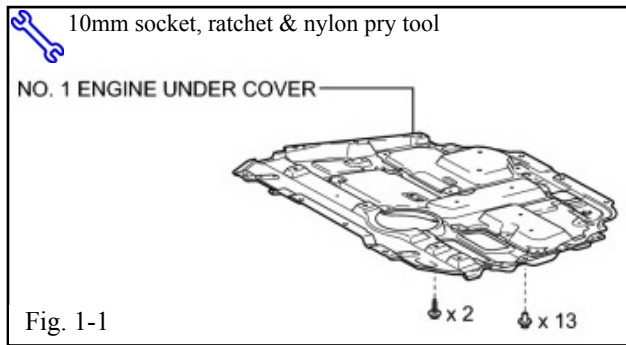

- (1) Use a 10mm socket to remove the six bolts on the engine under cover and retain them for reinstallation (Fig. 1-1).
- (2) Use a nylon pry tool to remove the 12 clips and retain them for reinstallation (Fig. 1-1).

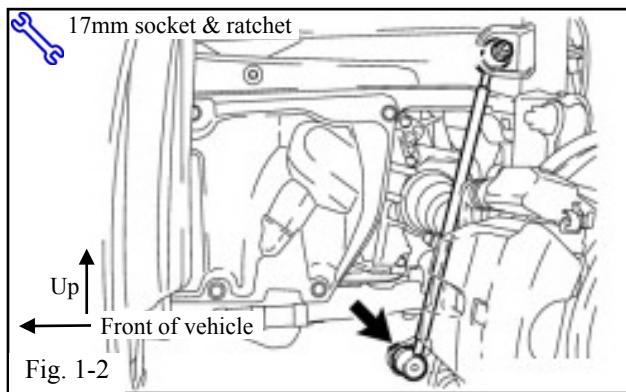

- (c) Use a 17mm socket to remove the lower nut (black arrow) on the sway bar from the end links on the RH and LH side of the vehicle and retain them for reinstallation (Fig. 1-2).

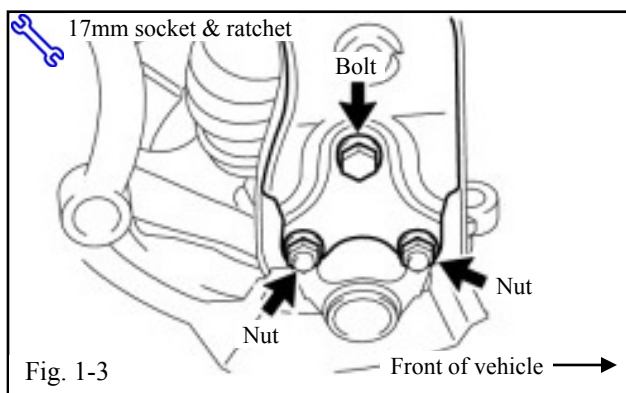

- (d) Remove the **driver side** lower control arm.
 - (1) Use a 17mm socket to remove the two nuts and one bolt from the outer portion of the lower control arm and retain them for reinstallation (Fig. 1-3).
 - (2) Pull the arm down and dislocate the lower ball joint assembly from the arm and then allow the arm to rise up to a neutral position.

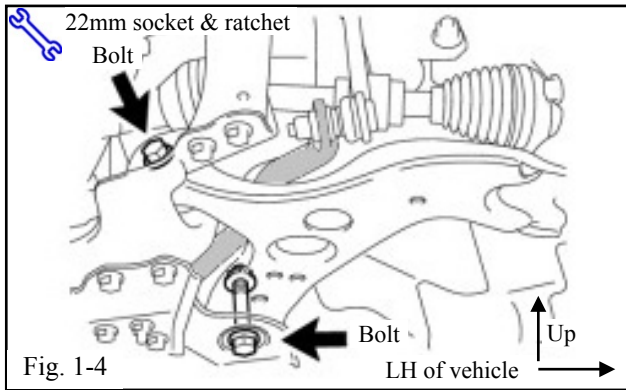

(3) Use a 22 mm socket to remove the two bolts from the inner portion of the lower control arm and retain them for reinstallation (Fig. 1-4).

STOP CAUTION: Take care not to damage the lower ball joint boot with the end of the control arm.

(4) Pull the lower control arm from the vehicle.

! HINT: Raise the end of the arm above the ball joint so that it is horizontal. This will unload the bushing and make it easy to pull out.

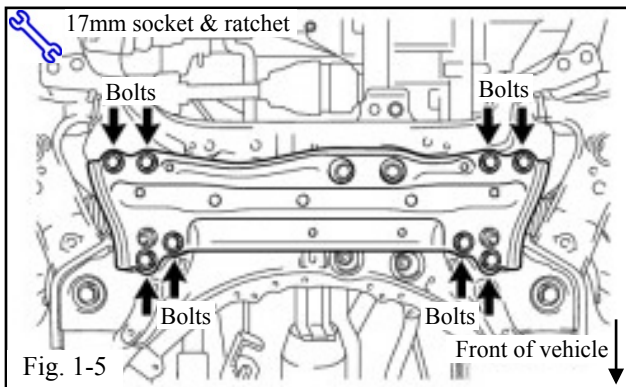

(e) Use a 17mm socket to remove the eight bolts and front suspension member brace and retain them for reinstallation (Fig. 1-5).

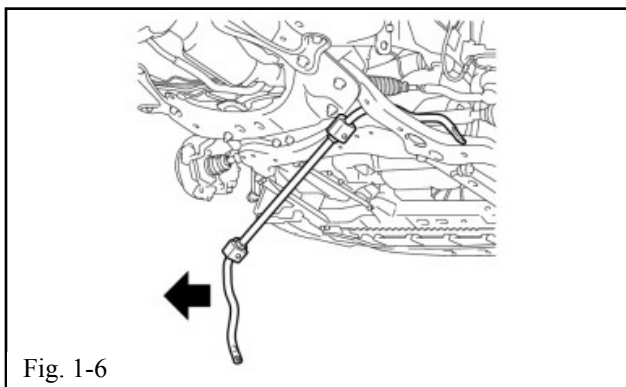

(f) Remove the front sway bar (Fig. 1-6).

! (1) Observe the orientation of the front sway bar prior to removing it.

(2) Free the sway bar ends from the end links.

(3) Remove and discard the front sway bar and sway bar bushings.

2. Install the F-Sport Front Sway Bar.

(a) Install the front sway bar bushings.

- (1) Install the front sway bar bushing so that the dust lips face the outside of the vehicle *1 (Fig. 2-1).
- (2) Install the front sway bar bushings so that the cutouts face the rear of the vehicle.

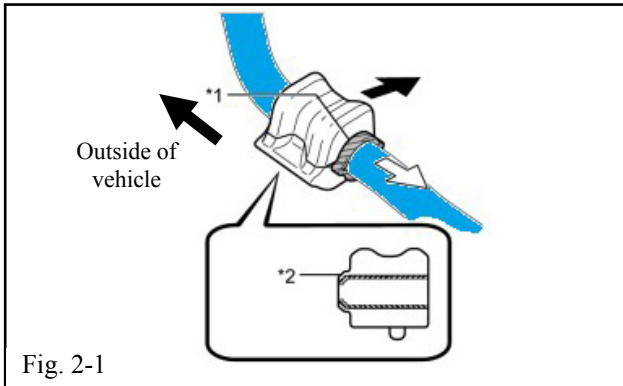

(b) Temporarily place the front sway bar on the sub-frame assembly in the same orientation as the original sway bar (Fig. 2-2).

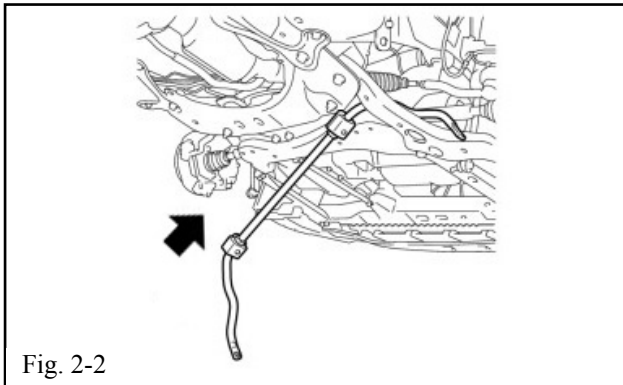

(c) Use a 17mm socket to reinstall the front suspension member brace with the eight OE bolts (Fig. 2-3). Torque the bolts to 92 N·m (68 ft·lbf).

⚠ Torque: 92 N·m (68 ft·lbf)

(d) Install the lower control arm back into position on the sub-frame assembly.

⚠ HINT: Hold the arm in a horizontal position to slide the arm into place.

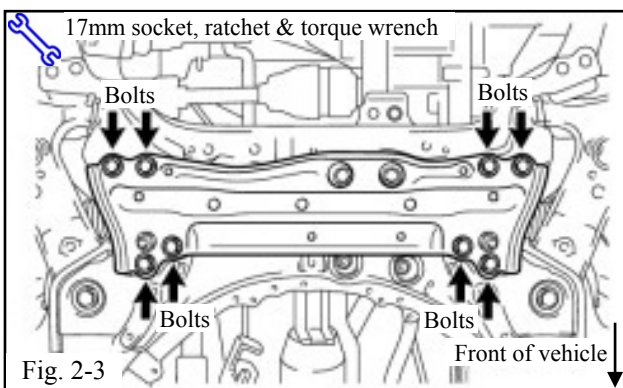

(e) Install the **driver side** lower control arm.

(1) Position the end of the control arm above the lower ball joint assembly. The control arm should be horizontal.

(2) Use a 22mm socket to reinstall the inner bolts of the lower control arm (Fig. 2-4). Torque bolt A to 233 N•m (172 ft•lbf) and bolt B to 214 N•m (158 ft•lbf).

⚠ Torque, Bolt A: 233 N•m (172 ft•lbf)

⚠ Torque, Bolt B: 214 N•m (158 ft•lbf)

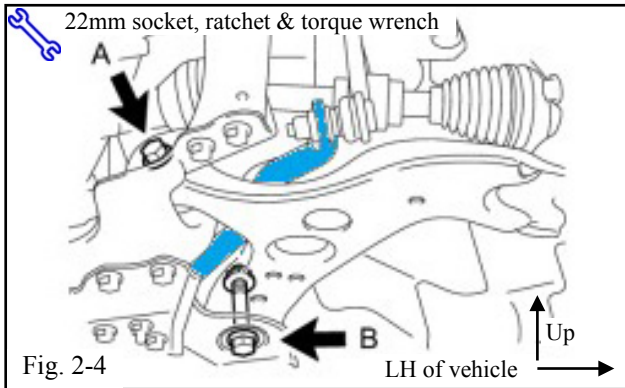

(3) Use a 17mm socket to reinstall the two nuts and one bolt to assemble the outer portion of the lower control arm to the lower ball joint assembly (Fig. 2-5).

⚠ Torque: 89 N•m (66 ft•lbf)

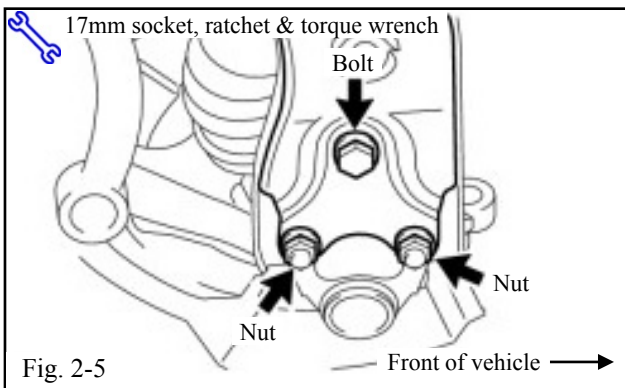

(f) Attach the front end link assemblies.

(1) Attach the LH and RH front end link assemblies to the appropriate hole on the front sway bar ends as indicated in the illustration (Fig. 2-6).

⚠ NOTE: Installation of the front sway bar depends on the type of springs installed on the vehicle.

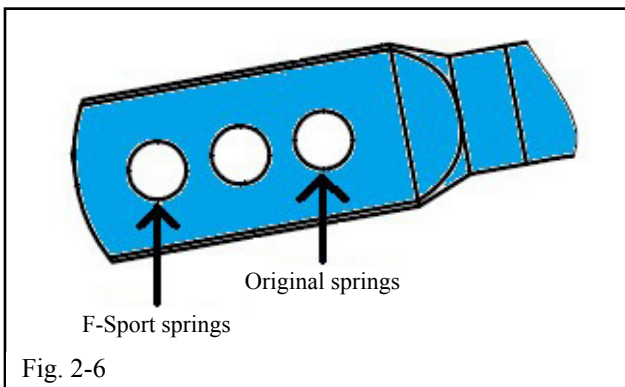

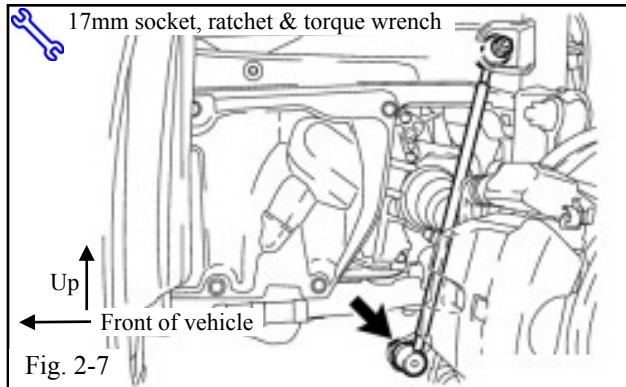

- (2) Use a 17mm socket to reinstall the nut to attach the sway bar to the end links on the LH and RH sides of the vehicle (Fig. 2-7). Torque the bolts to 74 N•m (55 ft•lbf).

⚠ Torque: 74 N•m (55 ft•lbf)

- (g) Reinstall the engine under cover.

- (1) Reinstall the 12 clips.

- (2) Use a 10mm socket to reinstall the six bolts on the engine under cover.

- (h) Use a 21mm socket to reinstall the front wheel assembly. Torque the lug nuts to 103 N•m (76 ft•lbf).

⚠ Torque: 103 N•m (76 ft•lbf)

3. Remove the OE Rear Sway Bar.

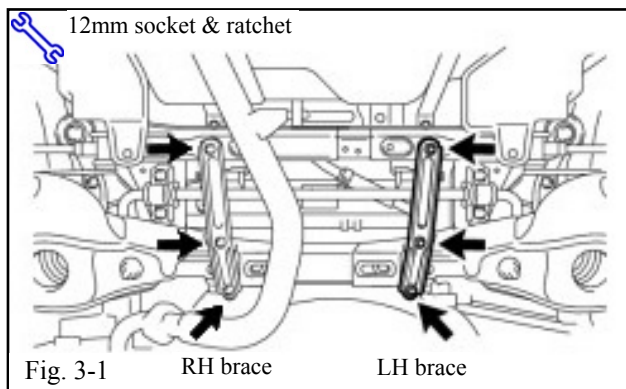

- (a) Use a 12mm socket to remove the six bolts from the LH and RH member braces (three bolts per brace); remove the suspension member and retain the bolts and braces for reinstallation (Fig. 3-1).

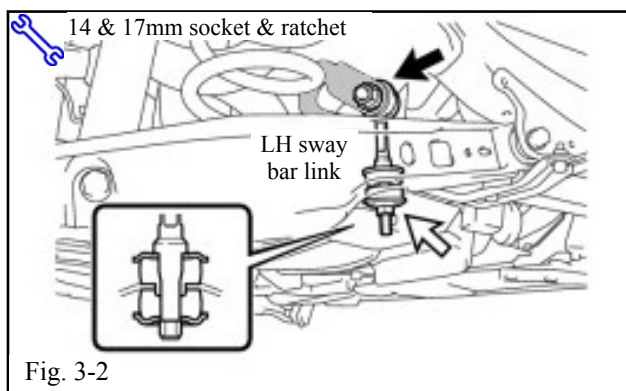

- (b) Use a 17mm socket to remove the upper nut from the LH and RH sway bar link assemblies (black arrow, Fig. 3-2) and retain them for reinstallation.

(c) Loosen (but do NOT remove) the lock nut on the bottom sway bar link assembly.

(1) Before loosening the lock nut, apply lightweight oil to the threads on the lower end of the sway bar link.

(2) Use a 14mm socket to loosen the lock nut at the bottom of the sway bar link assembly (white arrow, Fig. 3-2).

(d) Use a 10mm socket to remove the two bolts and disengage the two claws to remove the rear suspension arm cover from the rear No. 2 suspension arm assembly on the LH and RH side (four bolts total); retain them for reinstallation (Fig. 3-3).

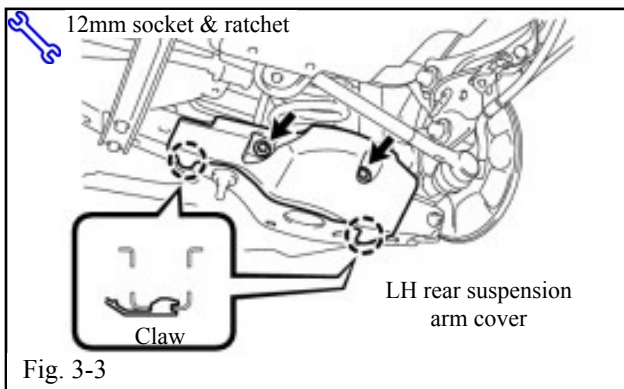

(e) Remove the rear sway bar (Fig. 3-4).

! (1) Observe the orientation of the front sway bar prior to removing it.

(2) Use a 14mm socket to remove the four bolts and the two rear No. 1 sway bar brackets from the rear suspension member sub-assembly; retain the bolts for reinstallation.

(3) Remove and discard the rear sway bar, sway bar bushings and sway bar brackets.

! **HINT:** Pull down on the exhaust pipe momentarily to allow removal of the sway bar.

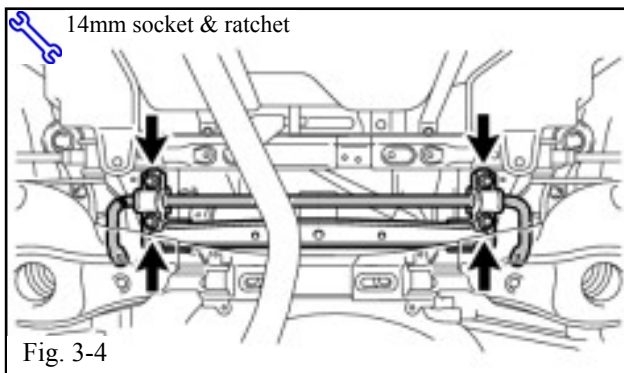

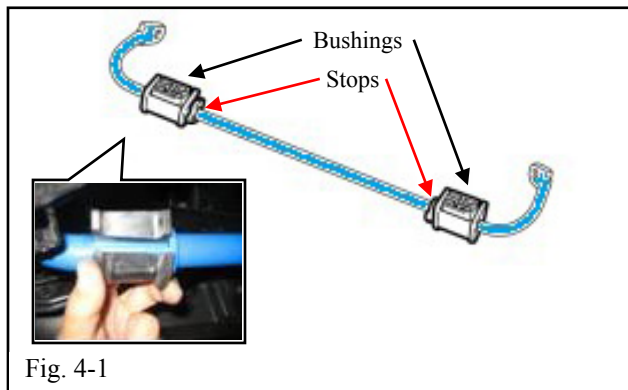

Fig. 4-1

4. Install the F-Sport Rear Sway Bar.

- (a) Install the two rear sway bar bushings (black arrows, Fig. 4-1) to the rear sway bar on the outside of the bushing stops (red arrows, Fig. 4-1).

⚠ NOTE: The direction of the slit in the bushing is not critical. Copy the factory condition if possible.

- (b) Install the rear sway bar.

- (1) Hang a rag on the exhaust pipe to protect the vehicle and sway bar paint.
- (2) Temporarily install the sway bar to the sway bar link assemblies on the RH and LH side.
- (3) Confirm the bar is orientated correctly before proceeding with the installation. The sway bar should be installed and orientated with the arrow pointed up (Fig. 4-2).



Fig. 4-2

- (4) Confirm the bends on the sway bar ends are orientated correctly (red lines, Fig. 4-3).
- (5) Use a tape measure to confirm a clearance of at least two inches between the sway bar and the rear suspension arm (Fig. 4-3).

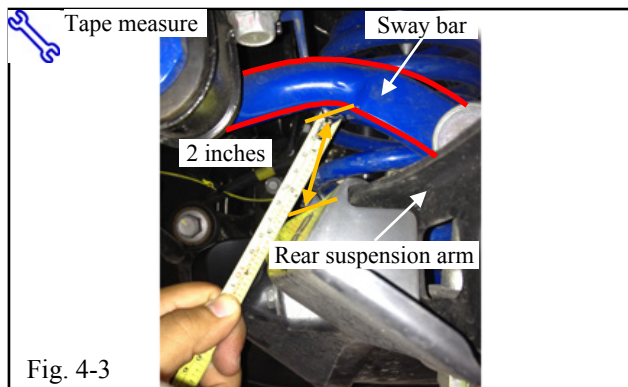
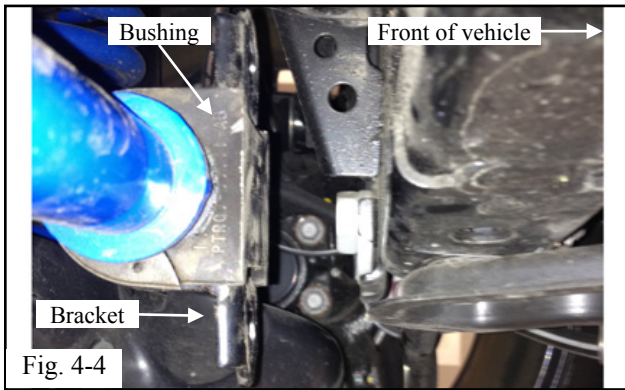
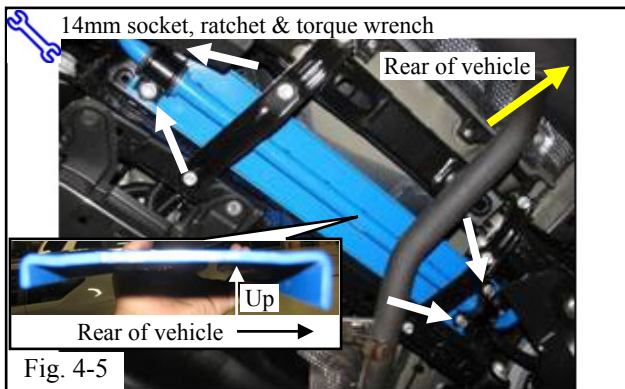

Fig. 4-3



(6) Push the supplied bar brackets onto the bushings and orient the brackets and bushings so that the flat mounting surface is facing towards the front of the vehicle to help in the installation of the rear chassis brace (Fig. 4-4).



(c) Place the new rear chassis brace on top of the rear sway bar with the taller flange towards the rear of the vehicle (Fig. 4-5).

(d) Use a 14mm socket to install the rear chassis brace, rear stabilizer bar, bushings and rear sway bar brackets to the rear suspension member with the four OE bolts (white arrows, Fig. 4-5). Torque the OE bolts to 78 N·m (58 ft·lbf).

⚠ Torque: 78 N·m (58 ft·lbf).

(e) Fasten the rear sway bar link assemblies.

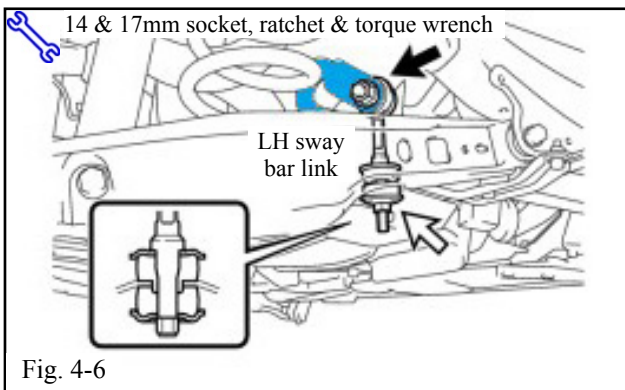

(1) Use a 17mm socket to reinstall and tighten the upper nuts on the LH and RH side (Fig. 4-6). Torque the upper nuts to 95 N·m (70 ft·lbf).

⚠ Torque: 95 N·m (70 ft·lbf)

(2) Use a 14mm socket to tighten the lower lock nuts on the LH and RH side (Fig. 4-6). Torque the lower lock nuts to 30 N·m (22 ft·lbf).

■ Torque: 30 N·m (22 ft·lbf)

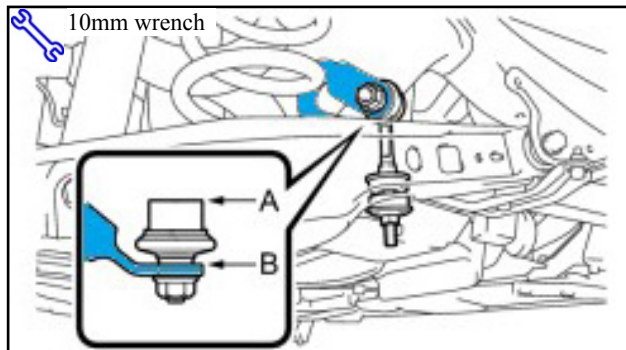

- (3) Use a 10 mm wrench to rotate the link assembly (A) so that it is parallel to the sway bar end (B) (Fig. 4-7 & Fig. 4-8).

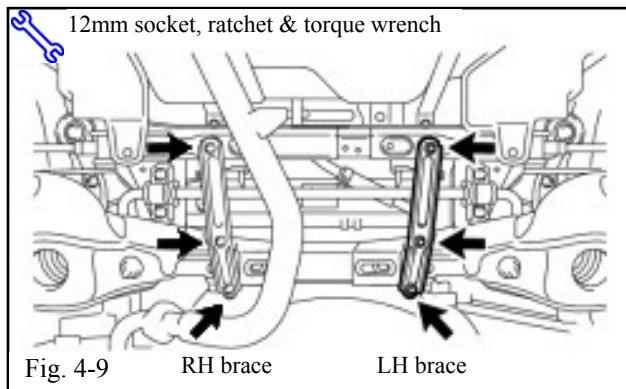
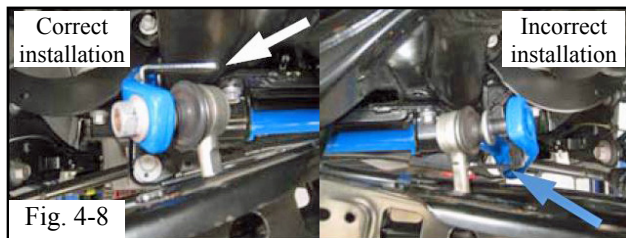

- (f) Use a 12mm socket to reinstall the LH and RH rear suspension member braces to the rear suspension member with the six OE bolts (Fig. 4-9). Torque the bolts to 35 N·m (26 ft·lbf).

Torque: 35 N·m (26 ft·lbf)

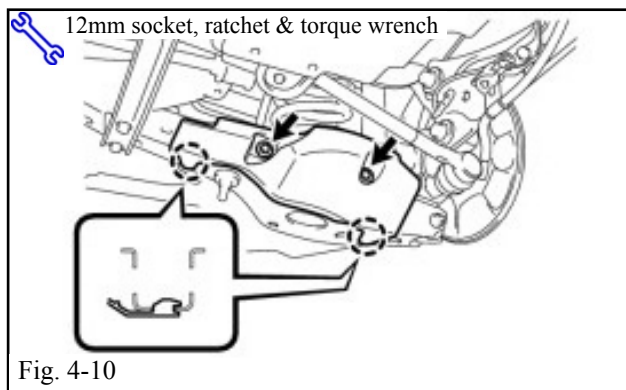

- (g) Reinstall the rear suspension arm covers (Fig. 4-10).
- (1) Insert the two claws of the rear suspension arm cover into the rear No. 2 suspension arm assembly.
- (2) Use a 12mm socket to reinstall the rear suspension arm cover with the two OE bolts. Torque the OE bolts to 12 N·m (108 in·lbf).

Torque: 12 N·m (108 in·lbf)

NOTE: Make sure that the two claws of the rear suspension arm cover are inserted.

Checklist - these points **MUST** be checked to ensure a quality installation.

Check:	Look For:
<p><u>Accessory Function Checks</u></p> <p><input type="checkbox"/> Orientation of rear sway bar</p> <p><input type="checkbox"/> Clearance between sway bar and suspension arm</p> <p><input type="checkbox"/></p>	<p><u>Look For:</u></p> <p>Installed and orientated with arrow pointed up as shown in Fig. 4-2</p> <p>The bends on sway bar ends should be orientated correctly as shown in Fig. 4-3 (red lines)</p> <p>A minimum at least 2 inches of clearance between sway bar and rear suspension arm</p>
<p><u>Vehicle Function Checks</u></p> <p><input type="checkbox"/> Front stabilizer link assemblies</p> <p><input type="checkbox"/> Rear stabilizer link assemblies</p> <p><input type="checkbox"/></p>	<p>Installed using the hole indicated in Fig. 2-5</p> <p>Should be parallel to the sway bar ends</p>
	<p><u>Vehicle Appearance Check</u></p> <p><input type="checkbox"/> After accessory installation and removal of protective cover(s), perform a visual inspection.</p>

Checklist - these points **MUST** be checked to ensure a quality installation.

Check:

Look For:

Ensure no damage (including scuffs and scratches) was caused during the installation process.
(For PPO installations, refer to TMS Accessory Quality Shipping Standard.)